

TVS

TVS

## Description

The P6KE Series is designed specifically to protect sensitive electronic equipment from voltage transients induced by lightning and other transient voltage events.

## Applications

- Communication Equipment
- Security & Protection
- Industrial Control Equipment
- Power Supply
- Automotive Electronics
- New Energy
- Lightning Protection

## Functional Diagram

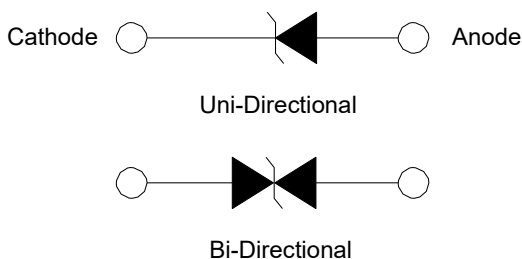

## Features

- 600 W peak pulse capability at 10/1000  $\mu$ S waveform, repetition rate (duty cycles):0.01%
- Glass passivated chip junction or Planar chip (< 10 V ) in DO-15 Package
- Fast response time: typically less than 1.0 PS from 0 Volts to BV min
- Excellent clamping capability
- Typical failure mode is short from over-specified voltage or current
- Whisker test is conducted per Table 4a/4c of JEDEC JESD201A
- IEC 61000-4-2 ESD 30 kV (Air), 30 kV (Contact)
- EFT protection of data lines in accordance with IEC 61000-4-4
- Low incremental surge resistance
- Typical  $I_R \leq 1.0 \mu A$  for  $V_{BR} \text{ min} > 12.6 V$
- Compatible with high temperature reflow soldering (260 °C/30 s)
- $V_{BR} @ T_J = V_{BR@25^\circ C} \times (1 + \alpha T \times (T_J - 25))$   
( $\alpha T$ : Temperature Coefficient, typical value is 0.1%)
- UL Recognized compound meeting flammability rating V-0
- Matte tin lead-free plated
- Halogen free and RoHS compliant
- Pb-free E3 means 2nd level interconnect is Pb-free and the terminal finish material is tin(Sn) (IPC/ JEDEC J-STD-609A.01)

## Package Outline Dimensions (DO-204AC/DO-15)

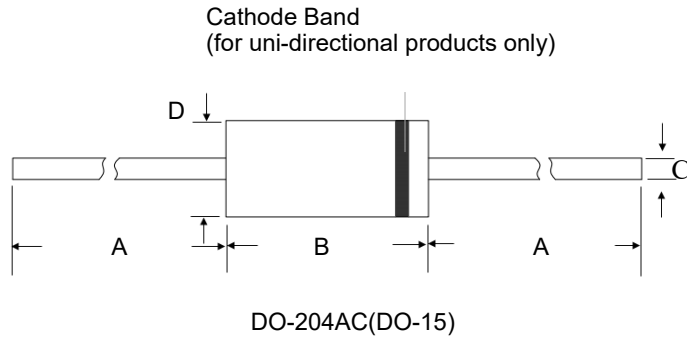

Symbol	Millimeters		Inches	
	Min.	Max.	Min.	Max.
A	25.40	-	1.000	-
B	5.80	7.60	0.230	0.300
C	0.71	0.86	0.028	0.034
D	2.60	3.60	0.104	0.140

## Maximum Ratings and Characteristics

( $T_A = 25\text{ }^\circ\text{C}$  unless otherwise specified.)

Parameter	Symbol	Value	Unit
Peak Pulse Power Dissipation(Fig.2) by 10/1000 uS Test Waveform(Fig.4) (Note 1) -Single Die Parts	$P_{PPM}$	600	W
Peak Pulse Power Dissipation(Fig.2) by 10/1000 uS Test Waveform(Fig.4) (Note 1) - Stacked Die Parts (Note 4)	$P_{PPM}$	800	W
Steady State Power Dissipation on Infinite Heat Sink at $T_L=75\text{ }^\circ\text{C}$	$P_D$	5.0	W
Peak Forward Surge Current, 8.3 ms Single Half Sine Wave Unidirectional Only (Note 2)	$I_{FSM}$	100	A
Maximum Instantaneous Forward Voltage at 50 A for Unidirectional Only (Note 3)	$V_F$	3.5/5.0	V
Operating Junction and Storage Temperature Range	$T_J, T_{STG}$	-55 to 175	$^\circ\text{C}$
Typical Thermal Resistance Junction to Lead	$R_{\theta JL}$	20	$^\circ\text{C/W}$
Typical Thermal Resistance Junction to Ambient	$R_{\theta JA}$	75	$^\circ\text{C/W}$

### Notes

1. Non-repetitive current pulse, per Fig. 4 and derated above  $T_J(\text{initial})=25\text{ }^\circ\text{C}$  per Fig. 3.
2. Measured of 8.3 ms single half sine-wave or equivalent square wave, duty cycle=4 pulses per minute maximum.
3.  $V_F < 3.5\text{ V}$  for single die parts and  $V_F < 5.0\text{ V}$  for stacked-die parts.
4. For stacked die component details, please refer to part numbers labeled by \* in Electrical Characteristics.

## Part Numbering System

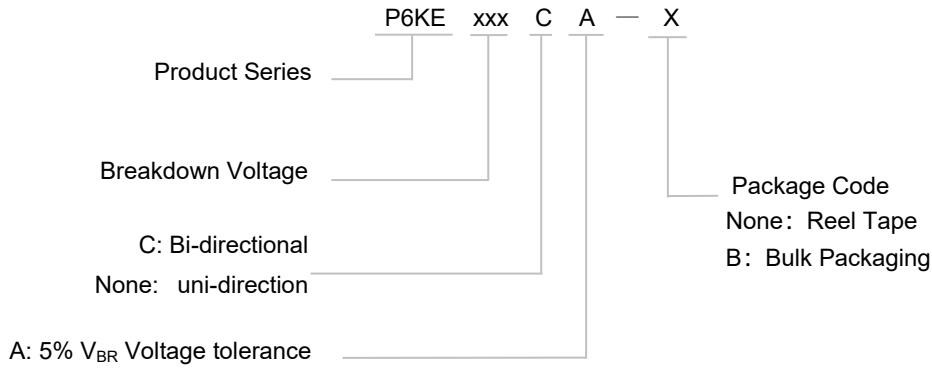

## Marking

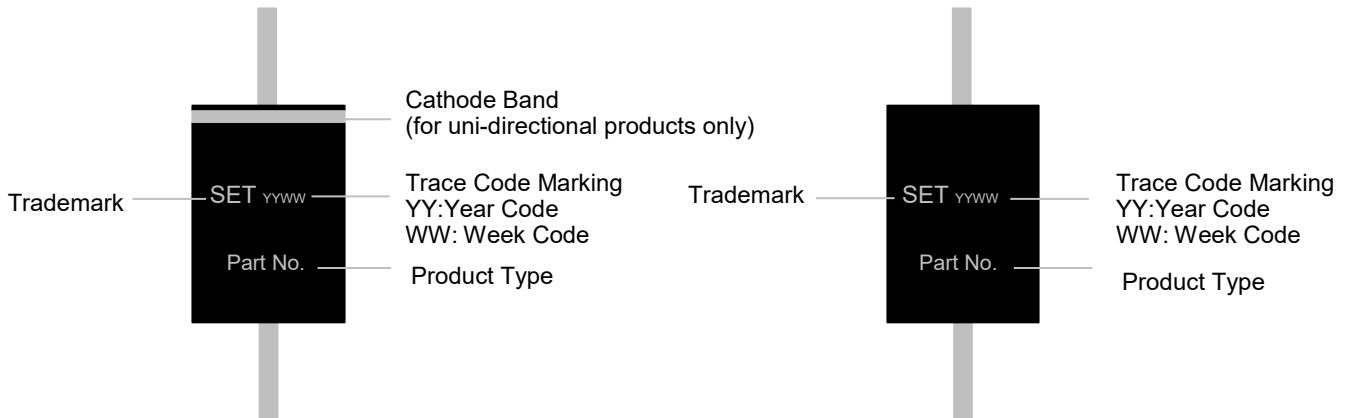

## Glossary

Item	Description
$V_C$	<b>Clamping Voltage</b> Voltage across TVS in a region of low differential resistance that serves to limit the voltage across the device terminals.
$V_R$	<b>Reverse Stand-off Voltage</b> Maximum voltage that can be applied to the TVS without operation. NOTE : It is also shown as $V_{WM}$ (maximum working voltage (maximum d.c. voltage)) and known as rated stand-off voltage ( $V_{so}$ ).
$I_R$	<b>Reverse Leakage Current</b> Current measured at $V_R$ . NOTE : Also shown as $I_D$ for stand-by current.
$V_{BR}$	<b>Breakdown Voltage</b> Voltage across TVS at a specified current $I_T$ in the breakdown region.
$I_{PPM}$	<b>Rated Random Recurring Peak Impulse Current</b> Maximum-rated value of random recurring peak impulse current that may be applied to a device.
$P_{M(AV)}$	<b>Rated Average Power Dissipation</b> Maximum-rated value of power dissipation resulting from all sources, including transients and standby current, averaged over a short period of time.
$P_{PPM}$	<b>Rated Random Recurring Peak Impulse Power Dissipation</b> Maximum-rated value of the product of rated random recurring peak impulse current ( $I_{PPM}$ ) multiplies by specified maximum clamping voltage ( $V_C$ ).
$C_J$	<b>Capacitance</b> Capacitance across the TVS measured at a specified frequency and voltage.
$V_{FS}$	<b>Peak Forward Surge Voltage</b> Peak voltage across an TVS for a specified forward surge current ( $I_{FS}$ ) and time duration. NOTE : Also shown as $V_F$ .
$I_{FS}$	<b>Forward Surge Current</b> Pulsed current through TVS in the forward conducting region. NOTE : Also shown as $I_F$ .
$\alpha_{V(BR)}$	<b>Temperature Coefficient of Breakdown Voltage</b> The change of breakdown voltage divided by the change of temperature.
$I_{PP}$	<b>Peak pulse Current</b> Peak pulse current value applied across the TVS to determine the clamping voltage $V_C$ for a specified wave shape.
$I_T$	<b>Pulsed D.C. Test Current</b> Test current for measurement of the breakdown voltage $V_{BR}$ . This is defined by the manufacturer and usually given in milliamperes with a pulse duration of less than 40 ms. NOTE : Also shown as $I_{BR}$ .

—(GB-T 18802.321 / IEC 61643-321 / JESD210A)

### Electrical Characteristics (T<sub>A</sub>=25 °C unless otherwise noted )Table 1

Part Number		Breakdown Voltage V <sub>BR@I<sub>T</sub></sub>		Test Current I <sub>T</sub>	Reverse Stand-off Voltage V <sub>R</sub>	Max. Reverse Leakage I <sub>R@V<sub>R</sub></sub>	Max. Peak Pulse Current I <sub>PPM</sub>	Max. Clamping Voltage V <sub>C@I<sub>PPM</sub></sub>
		Min	Max					
Uni	Bi	(V)		(mA)	(V)	(μA)	(A)	(V)
P6KE6.8A	P6KE6.8CA	6.45	7.14	10	5.80	1000	58.1	10.5
P6KE7.5A	P6KE7.5CA	7.13	7.88	10	6.40	500	54.0	11.3
P6KE8.2A	P6KE8.2CA	7.79	8.61	10	7.02	200	50.4	12.1
P6KE9.1A	P6KE9.1CA	8.65	9.55	1	7.78	50	45.5	13.4
P6KE10A	P6KE10CA	9.50	10.50	1	8.55	10	42.1	14.5
P6KE11A	P6KE11CA	10.50	11.60	1	9.40	5	39.1	15.6
P6KE12A	P6KE12CA	11.40	12.60	1	10.20	5	36.5	16.7
P6KE13A	P6KE13CA	12.40	13.70	1	11.10	1	33.5	18.2
P6KE15A	P6KE15CA	14.30	15.80	1	12.80	1	28.8	21.2
P6KE16A	P6KE16CA	15.20	16.80	1	13.60	1	27.1	22.5
P6KE18A	P6KE18CA	17.10	18.90	1	15.30	1	24.2	25.2
P6KE20A	P6KE20CA	19.00	21.00	1	17.10	1	22.0	27.7
P6KE22A	P6KE22CA	20.90	23.10	1	18.80	1	19.9	30.6
P6KE24A	P6KE24CA	22.80	25.20	1	20.50	1	18.4	33.2
P6KE27A	P6KE27CA	25.70	28.40	1	23.10	1	16.3	37.5
P6KE30A	P6KE30CA	28.50	31.50	1	25.60	1	14.7	41.4
P6KE33A	P6KE33CA	31.40	34.70	1	28.20	1	13.3	45.7
P6KE36A	P6KE36CA	34.20	37.80	1	30.80	1	12.2	49.9
P6KE39A	P6KE39CA	37.10	41.00	1	33.30	1	11.3	53.9
P6KE43A	P6KE43CA	40.90	45.20	1	36.80	1	10.3	59.3
P6KE47A	P6KE47CA	44.70	49.40	1	40.20	1	9.4	64.8
P6KE51A	P6KE51CA	48.50	53.60	1	43.60	1	8.7	70.1
P6KE56A	P6KE56CA	53.20	58.80	1	47.80	1	7.9	77.0
P6KE62A	P6KE62CA	58.90	65.10	1	53.00	1	7.2	85.0
P6KE68A	P6KE68CA	64.60	71.40	1	58.10	1	6.6	92.0

TVS

TVS

Part Number		Breakdown Voltage $V_{BR@I_T}$		Test Current $I_T$	Reverse Stand-off Voltage $V_R$	Max. Reverse Leakage $I_R@V_R$	Max. Peak Pulse Current $I_{PPM}$	Max. Clamping Voltage $V_C@I_{PPM}$
		Min	Max					
Uni	Bi	(V)		(mA)	(V)	( $\mu$ A)	(A)	(V)
P6KE75A	P6KE75CA	71.30	78.80	1	64.10	1	5.9	103.0
P6KE82A	P6KE82CA	77.90	86.10	1	70.10	1	5.4	113.0
P6KE91A	P6KE91CA	86.50	95.50	1	77.80	1	4.9	125.0
P6KE100A	P6KE100CA	95.00	105.00	1	85.50	1	4.5	137.0
P6KE110A	P6KE110CA	105.00	116.00	1	94.00	1	4.0	152.0
P6KE120A	P6KE120CA	114.00	126.00	1	102.00	1	3.7	165.0
P6KE130A	P6KE130CA	124.00	137.00	1	111.00	1	3.4	179.0
P6KE150A	P6KE150CA	143.00	158.00	1	128.00	1	2.9	207.0
P6KE160A	P6KE160CA	152.00	168.00	1	136.00	1	2.8	219.0
P6KE170A	P6KE170CA	162.00	179.00	1	145.00	1	2.6	234.0
P6KE180A	P6KE180CA	171.00	189.00	1	154.00	1	2.5	246.0
P6KE200A	P6KE200CA	190.00	210.00	1	171.00	1	2.2	274.0
P6KE220A	P6KE220CA	209.00	231.00	1	185.00	1	1.9	328.0
P6KE250A	-	237.00	263.00	1	214.00	1	1.8	344.0
-	P6KE250CA*	237.00	263.00	1	214.00	1	2.4	344.0
P6KE300A	-	285.00	315.00	1	256.00	1	1.5	414.0
-	P6KE300CA*	285.00	315.00	1	256.00	1	2.0	414.0
P6KE350A*	P6KE350CA*	332.00	368.00	1	300.00	1	1.7	482.0
P6KE400A*	P6KE400CA*	380.00	420.00	1	342.00	1	1.5	548.0
P6KE440A*	P6KE440CA*	418.00	462.00	1	376.00	1	1.4	602.0
P6KE480A*	P6KE480CA*	456.00	504.00	1	408.00	1	1.3	658.0
P6KE510A*	P6KE510CA*	485.00	535.00	1	434.00	1	1.2	698.0
P6KE530A*	P6KE530CA*	503.50	556.50	1	451.00	1	1.2	725.0
P6KE540A*	P6KE540CA*	513.00	567.00	1	460.00	1	1.1	740.0
P6KE550A*	P6KE550CA*	522.50	577.50	1	468.00	1	1.1	760.0
P6KE600A*	P6KE600CA*	570.00	630.00	1	512.00	1	1.0	828.0

**Notes:**

1. Measured of 8.3 ms single half sine-wave or equivalent square wave, duty cycle=4 pulses per minute maximum.
2.  $V_F < 3.5$  V for single die parts and  $V_F < 5.0$  V for stacked-die parts.
3. For stacked die component details, please refer to models marked with \* in electrical characteristics table.
4. For bidirectional type having  $V_R$  of 10 volts and less, the  $I_R$  should be doubled.

## I-V Curve Characteristics

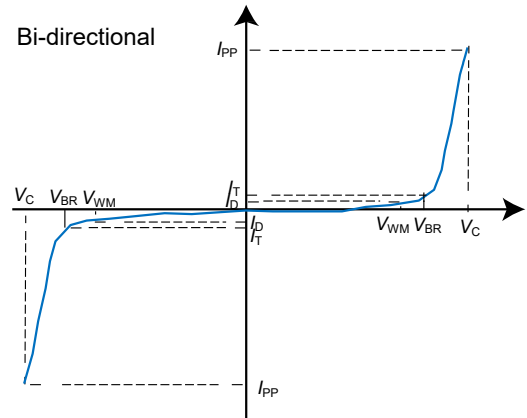
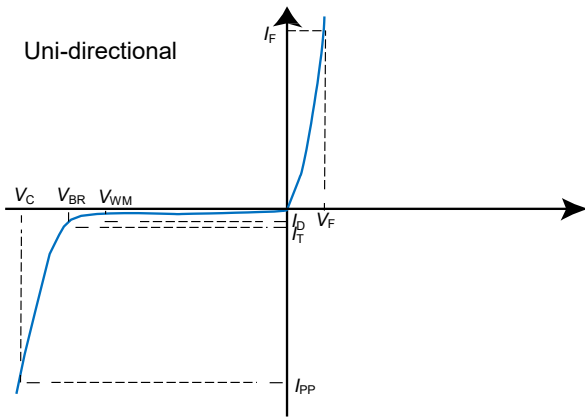

## Performance Curve for Reference ( $T_A=25^\circ\text{C}$ unless otherwise noted)

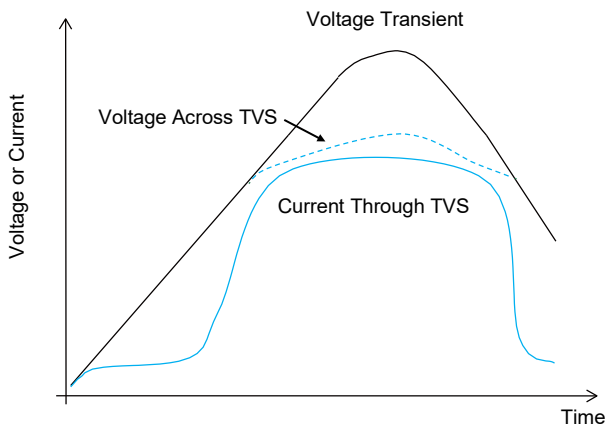

FIGURE 1 TVS Transients Clamping Waveform

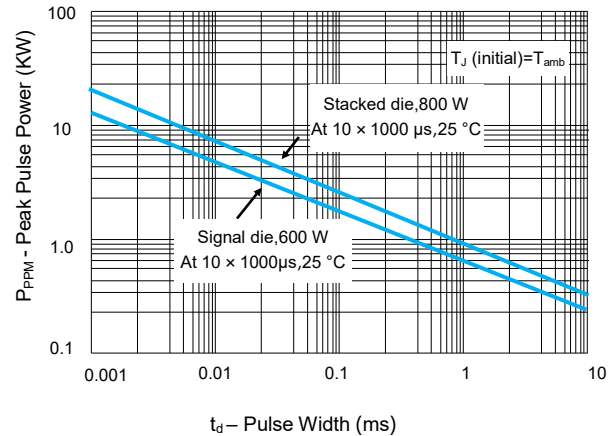

FIGURE 2 Peak Pulse Power Rating Curve

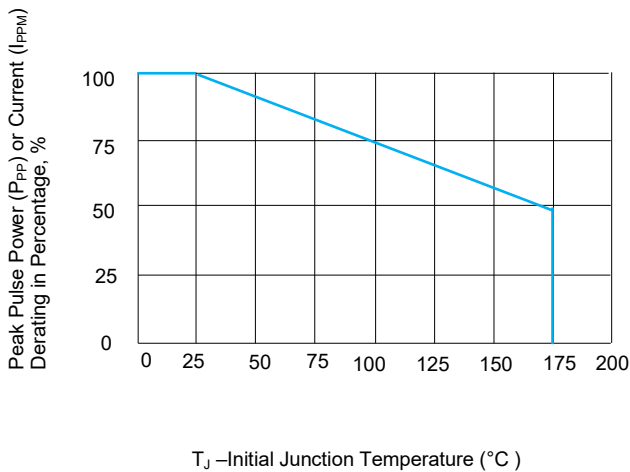

FIGURE 3 Peak Pulse Power Derating Curve

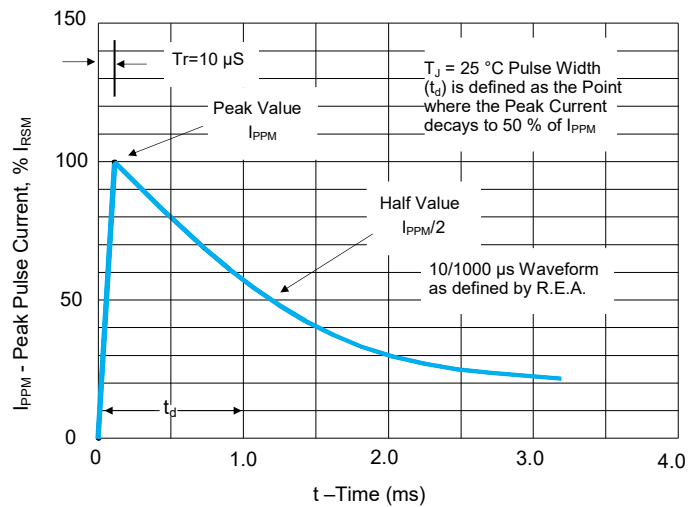

FIGURE 4 Pulse Waveform

TVS

TVS

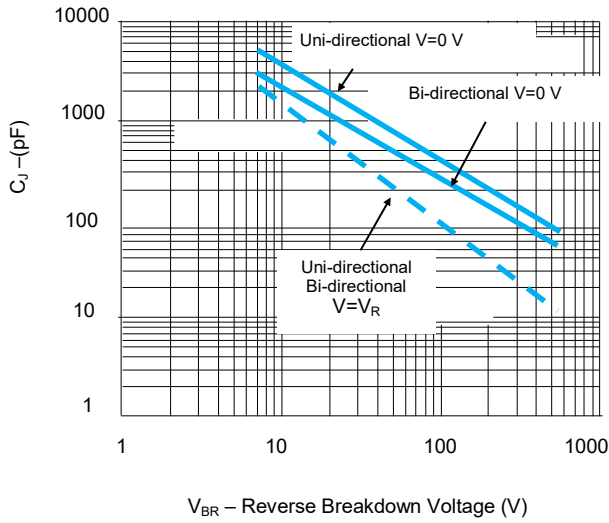

FIGURE 5 Typical Junction Capacitance

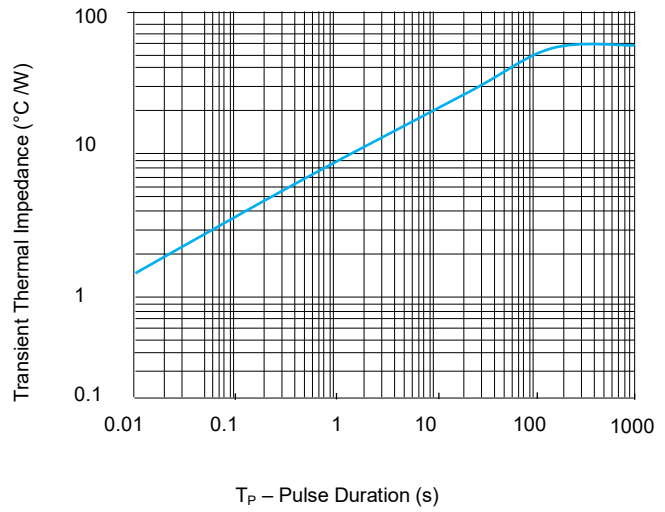

FIGURE 6 Typical Transient Thermal Impedance

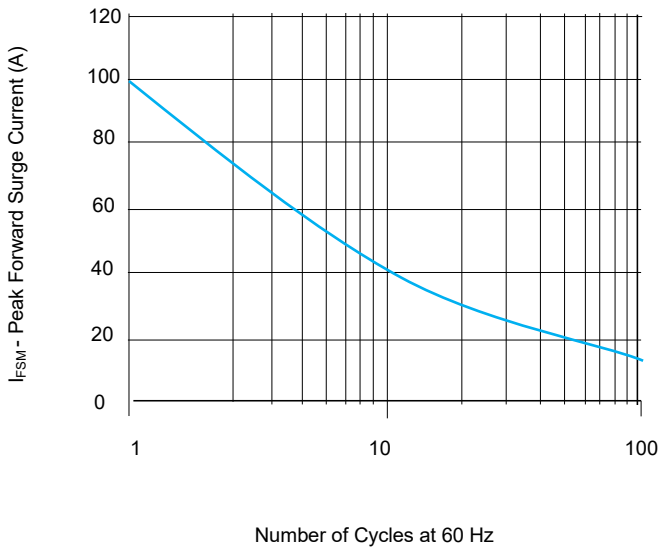

FIGURE 7 Maximum Non-Repetitive Forward Surge Current  
Uni-Directional only

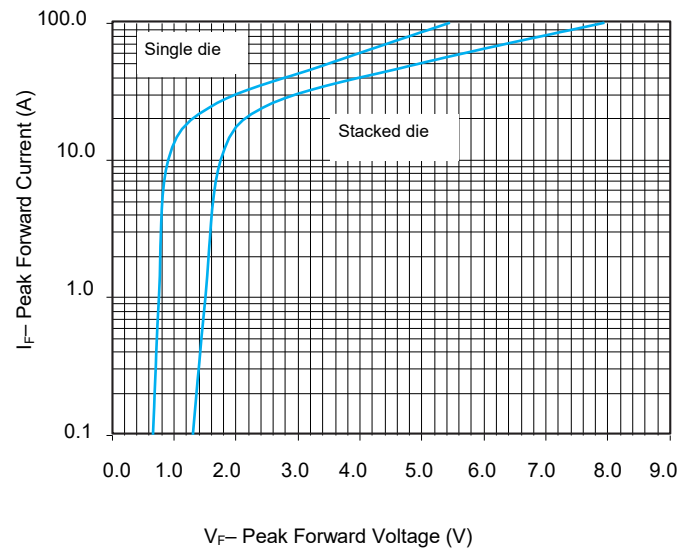

FIGURE 8 Peak Forward Drop vs Peak Forward Current  
(Typical Values)

## Environmental Specifications

High Temp. Storage	JESD22-A103
HTRB	JESD22-A108
Temperature Cycling	JESD22-A104
H3TRB	JESD22-A101
RSH	JESD22-B106

## Physical Specifications

Weight	0.015 oz., 0.4 g
Case	JEDEC DO-204AC (DO-15) molded plastic body over passivated junction.
Polarity	Color band denotes the cathode except Bipolar.
Terminal	Matte Tin axial leads, solderable per JESD22-B102.



## Soldering Parameters

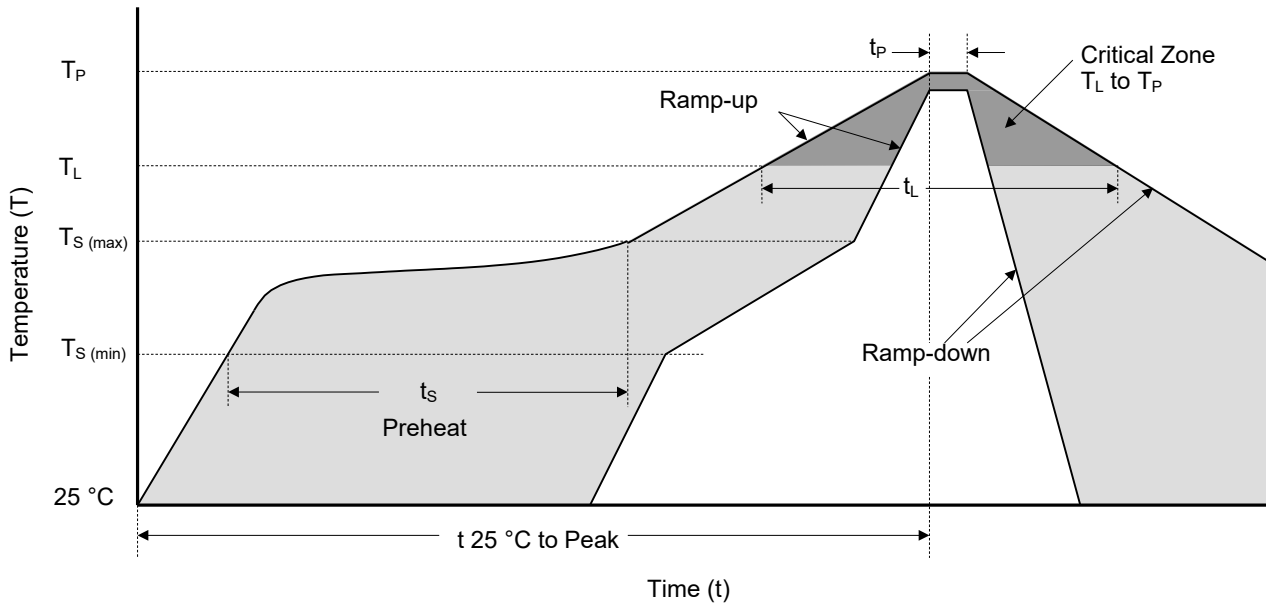

Reflowing Condition

Reflow Soldering Parameters		Lead-Free Assembly
Pre-heat	Temperature Min ( $T_{S (min)}$ )	150 °C
	Temperature Max ( $T_{S (max)}$ )	200 °C
	Time (min to max) ( $t_s$ )	60 ~ 120 seconds
Average Ramp Up Rate (Liquidus Temp ( $T_L$ ) to Peak)		3 °C / second max.
$T_{S (max)}$ to $T_L$ Ramp-up Rate		3 °C / second max.
Reflow	Temperature ( $T_L$ ) (Liquidus)	217 °C
	Time (min to max) ( $t_L$ )	60 ~ 150 seconds
Peak Temperature ( $T_P$ )		260 <sup>+0/-5</sup> °C
Time of within 5 °C of Actual Peak Temperature ( $t_p$ )		20 ~ 40 seconds
Ramp-down Rate		6 °C / second max.
Time from 25 °C to Peak Temperature		8 Minutes max.
Do Not Exceed		260 °C

## Flow/Wave Soldering (Solder Dipping)

Peak Temperature	260 °C+0 /- 5 °C
Dipping Time	10 seconds
Soldering Number	1 time

## Packaging Information

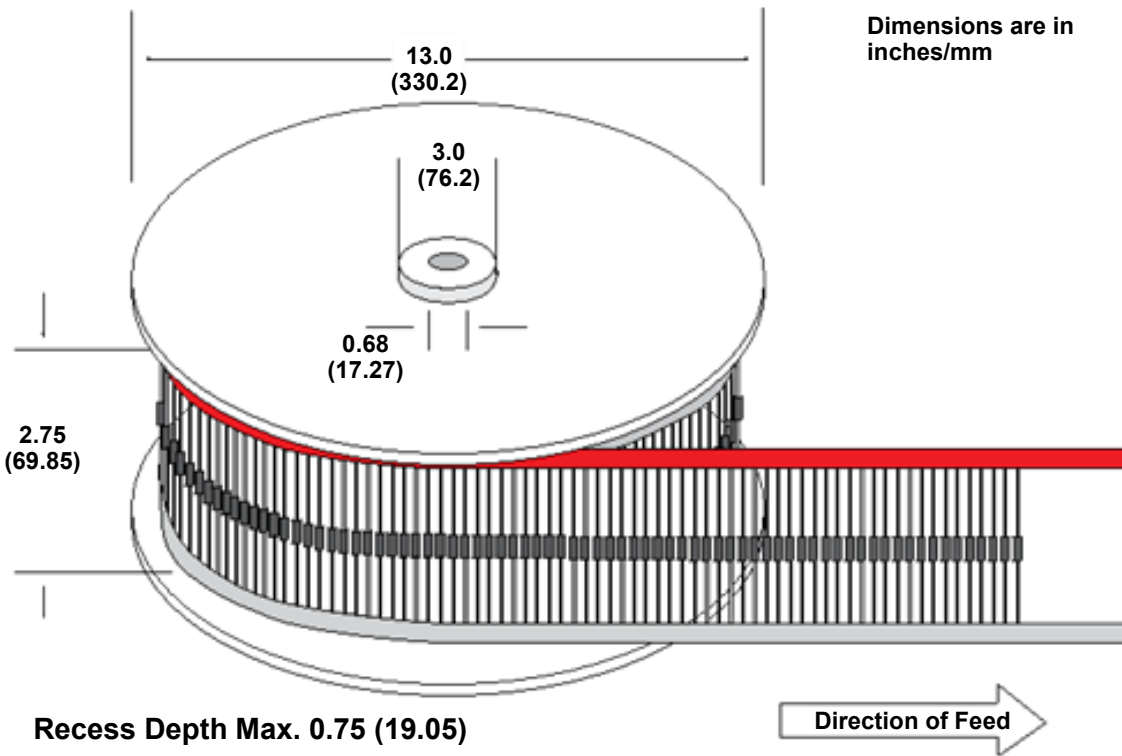
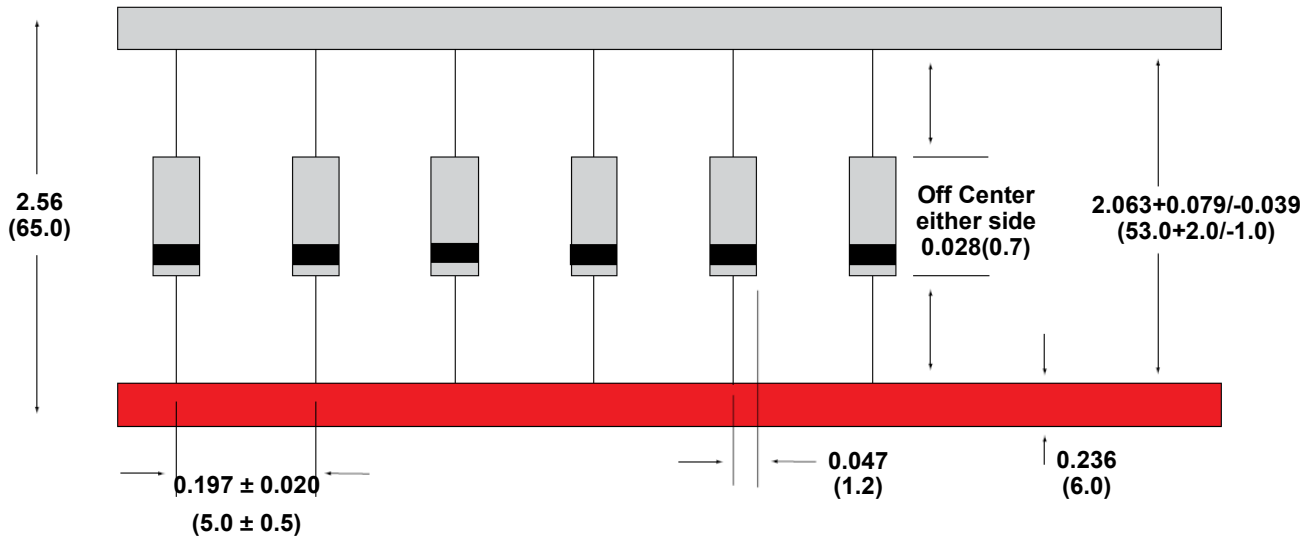

Part Number	Package	QTY's (Reel)	Packaging Option	Packaging Specification
P6KExxxXX	DO-204AC	4000 PCS	Tape & Reel	EIA STD RS-296
P6KExxxXX-TB	DO-204AC	3000 PCS	TB	/
P6KExxxXX-B	DO-204AC	1000 PCS	BULK	SETsafe   SETfuse Spec



## ATTENTION

### Usage

1. TVS must be operated in the specified ambient temp.
2. Do not clean the TVS with strong polar solvent such as ketone, esters, benzene and halogenated hydrocarbon, to avoid damaging the encapsulating layer.
3. Please do not apply severe vibration, shock or pressure to TVS, to avoid element cracking.

### Replacement

1. If TVS is visually damaged, please replace it.
2. TVS is a non-repairable product. For safety sake, please use equivalent TVS for replacement.

### Storage

1. Storage Temp. Range: (-55 to 150) °C.
2. Do not store the TVS at the high temp., high humidity or corrosive gas environment, to avoid influencing the solder-ability of the lead wires. The product shall be used up within 1 year after receiving the goods.

### Environmental Conditions

1. TVS should not be exposed to the open air, nor direct sunshine.
2. TVS should avoid rain, water vapor or other condition of high temp. and high humidity.
3. TVS should avoid sand dust, salt mist, or other harmful gases.

### Max. Typical Capacitance of TVS

The typical capacitance of TVS is listed in the specifications. Designers may refer to it when designing TVS in High frequency circuit.

### Installation Mechanical Stress

1. Do not knock TVS when installing, to avoid mechanical damage.
2. Please do not apply severe vibration, shock or pressure to TVS, to avoid surface resin or element cracking.