

TVS

TVS

Description

The P4KE Series is designed specifically to protect sensitive electronic equipment from EFTs, ESD, and induced lightning transients.

Applications

- Communication Equipment
- Security & Protection
- Industrial Control Equipment
- Power Supply
- Automotive Electronics
- New Energy
- Lightning Protection

Functional Diagram

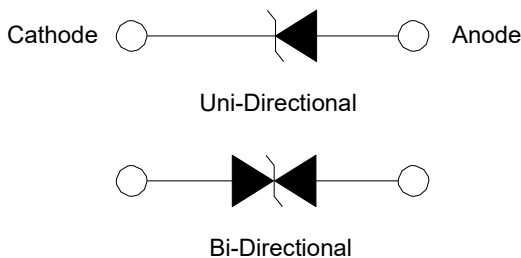

Features

- 400 W peak pulse capability at 10/1000 μ S waveform, repetition rate (duty cycles):0.01%
- Glass passivated chip junction or Planar chip (< 10 V) in DO-41 Package
- Fast response time: typically less than 1.0 PS from 0 Volts to V_{BR} min
- Excellent clamping capability
- Typical failure mode is a short circuit
- Whisker test is conducted per Table 4a/4c of JEDEC JESD201A
- IEC 61000-4-2 ESD 30 kV (Air), 30 kV (Contact)
- EFT protection of data lines in accordance with IEC 61000-4-4
- Low incremental surge resistance
- Typical $I_R \leq 1 \mu A$ for V_{BR} min > 12.6 V
- High temperature reflow soldering guaranteed: 260 °C/30 sec / 0.375", (9.5 mm) lead length, 5 lbs., (2.3 kg) tension
- $V_{BR} @ T_J = V_{BR@25^\circ C} \times (1 + \alpha T \times (T_J - 25))$
(αT : Temperature Coefficient, typical value is 0.1%)
- UL Recognized compound meeting flammability rating V-0
- Halogen free and RoHS compliant
- Pb-free E3 means 2nd level interconnect is Pb-free and the terminal finish material is tin(Sn) (IPC/ JEDEC J-STD-609A.01)

Package Outline Dimensions (DO-204AL/DO-41)

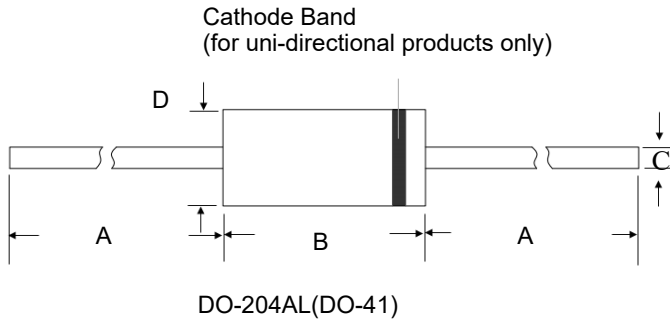

Symbol	Millimeters		Inches	
	Min.	Max.	Min.	Max.
A	25.40	-	1.000	-
B	4.10	5.20	0.160	0.205
C	0.71	0.86	0.028	0.034
D	2.00	2.70	0.080	0.107

Maximum Ratings and Characteristics

($T_A = 25^\circ\text{C}$ unless otherwise specified.)

Parameter	Symbol	Value	Unit
Peak Pulse Power Dissipation(Fig.2) by 10/1000 μS Test Waveform(Fig.4) (Note 1) - Single Die Parts	P_{PPM}	400	W
Peak Pulse Power Dissipation(Fig.2) by 10/1000 μS Test Waveform(Fig.4) (Note 1) - Stacked Die Parts (Note 4)	P_{PPM}	600	W
Steady State Power Dissipation on Infinite Heat Sink at $T_L=75^\circ\text{C}$	P_D	1.5	W
Peak Forward Surge Current, 8.3 ms Single Half Sine Wave Unidirectional Only (Note 2)	I_{FSM}	60	A
Maximum Instantaneous Forward Voltage at 25 A for Unidirectional Only (Note 3)	V_F	3.5/5.0	V
Operating Junction and Storage Temperature Range	T_J, T_{STG}	-55 to 175	$^\circ\text{C}$
Typical Thermal Resistance Junction to Lead	$R_{\theta JL}$	60	$^\circ\text{C/W}$
Typical Thermal Resistance Junction to Ambient	$R_{\theta JA}$	100	$^\circ\text{C/W}$

Notes

1. Non-repetitive current pulse, per Fig. 4 and derated above $T_J(\text{initial})=25^\circ\text{C}$ per Fig. 3.
2. Measured of 8.3 ms single half sine-wave or equivalent square wave, duty cycle=4 pulses per minute maximum.
3. $V_F < 3.5\text{ V}$ for single die parts and $V_F < 5.0\text{ V}$ for stacked-die parts.
4. For stacked die component details, please refer to part numbers labeled by * in Electrical Characteristics.

Part Numbering System

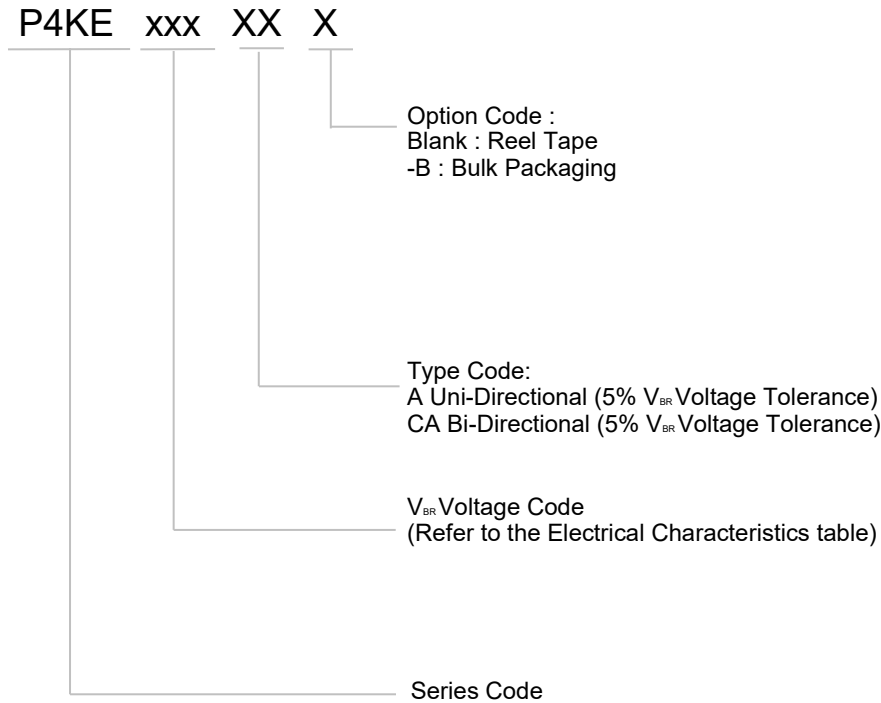

Marking

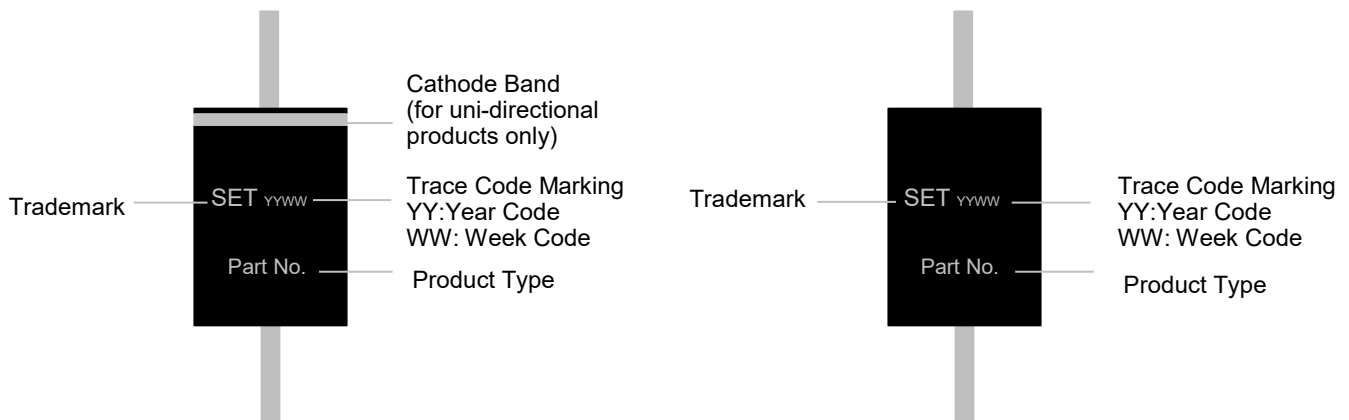

Glossary

Item	Description
V_C	Clamping Voltage Voltage across TVS in a region of low differential resistance that serves to limit the voltage across the device terminals.
V_R	Reverse Stand-off Voltage Maximum voltage that can be applied to the TVS without operation. NOTE : It is also shown as V_{WM} (maximum working voltage (maximum d.c. voltage)) and known as rated stand-off voltage (V_{SO}).
I_R	Reverse Leakage Current Current measured at V_R . NOTE : Also shown as I_D for stand-by current.
V_{BR}	Breakdown Voltage Voltage across TVS at a specified current I_T in the breakdown region.
I_{PPM}	Rated Random Recurring Peak Impulse Current Maximum-rated value of random recurring peak impulse current that may be applied to a device.
$P_{M(AV)}$	Rated Average Power Dissipation Maximum-rated value of power dissipation resulting from all sources, including transients and standby current, averaged over a short period of time.
P_{PPM}	Rated Random Recurring Peak Impulse Power Dissipation Maximum-rated value of the product of rated random recurring peak impulse current (I_{PPM}) multiplies by specified maximum clamping voltage (V_C).
C_J	Capacitance Capacitance across the TVS measured at a specified frequency and voltage.
V_{FS}	Peak Forward Surge Voltage Peak voltage across an TVS for a specified forward surge current (I_{FS}) and time duration. NOTE : Also shown as V_F .
I_{FS}	Forward Surge Current Pulsed current through TVS in the forward conducting region. NOTE : Also shown as I_F .
$\alpha_{V(BR)}$	Temperature Coefficient of Breakdown Voltage The change of breakdown voltage divided by the change of temperature.
I_{PP}	Peak pulse Current Peak pulse current value applied across the TVS to determine the clamping voltage V_C for a specified wave shape.
I_T	Pulsed D.C. Test Current Test current for measurement of the breakdown voltage V_{BR} . This is defined by the manufacturer and usually given in milliamperes with a pulse duration of less than 40 ms. NOTE : Also shown as I_{BR} .

—(GB-T 18802.321 / IEC 61643-321 / JESD210A)

Electrical Characteristics (T_A=25 °C unless otherwise noted)Table 1

Part Number		Breakdown Voltage V _{BR} @I _T		Test Current I _T	Reverse Stand-off Voltage V _R	Max. Reverse Leakage I _R @V _R	Max. Peak Pulse Current I _{PPM}	Max. Clamping Voltage V _C @I _{PPM}
		Min	Max					
Uni	Bi	(V)		(mA)	(V)	(μA)	(A)	(V)
P4KE6.8A	P4KE6.8CA	6.45	7.14	10	5.80	1000	39.00	10.5
P4KE7.5A	P4KE7.5CA	7.13	7.88	10	6.40	500	36.30	11.3
P4KE8.2A	P4KE8.2CA	7.79	8.61	10	7.02	200	33.90	12.1
P4KE9.1A	P4KE9.1CA	8.65	9.55	1	7.78	50	30.60	13.4
P4KE10A	P4KE10CA	9.50	10.50	1	8.55	10	28.30	14.5
P4KE11A	P4KE11CA	10.50	11.60	1	9.40	5	26.30	15.6
P4KE12A	P4KE12CA	11.40	12.60	1	10.20	5	24.60	16.7
P4KE13A	P4KE13CA	12.40	13.70	1	11.10	1	22.50	18.2
P4KE15A	P4KE15CA	14.30	15.80	1	12.80	1	19.30	21.2
P4KE16A	P4KE16CA	15.20	16.80	1	13.60	1	18.20	22.5
P4KE18A	P4KE18CA	17.10	18.90	1	15.30	1	16.10	25.5
P4KE20A	P4KE20CA	19.00	21.00	1	17.10	1	14.80	27.7
P4KE22A	P4KE22CA	20.90	23.10	1	18.80	1	13.40	30.6
P4KE24A	P4KE24CA	22.80	25.20	1	20.50	1	12.30	33.2
P4KE27A	P4KE27CA	25.70	28.40	1	23.10	1	10.90	37.5
P4KE30A	P4KE30CA	28.50	31.50	1	25.60	1	9.90	41.4
P4KE33A	P4KE33CA	31.40	34.70	1	28.20	1	9.00	45.7
P4KE36A	P4KE36CA	34.20	37.80	1	30.80	1	8.20	49.9
P4KE39A	P4KE39CA	37.10	41.00	1	33.30	1	7.60	53.9
P4KE43A	P4KE43CA	40.90	45.20	1	36.80	1	6.90	59.3
P4KE47A	P4KE47CA	44.70	49.40	1	40.20	1	6.30	64.8
P4KE51A	P4KE51CA	48.50	53.60	1	43.60	1	5.80	70.1
P4KE56A	P4KE56CA	53.20	58.80	1	47.80	1	5.30	77.0
P4KE62A	P4KE62CA	58.90	65.10	1	53.00	1	4.80	85.0
P4KE68A	P4KE68CA	64.60	71.40	1	58.10	1	4.50	92.0

TVS

TVS

TVS Diodes

Transient Voltage Suppression Diodes

SETsafe

SET fuse

P4KE Series

Part Number		Breakdown Voltage $V_{BR@I_T}$		Test Current I_T	Reverse Stand-off Voltage V_R	Max. Reverse Leakage $I_R@V_R$	Max. Peak Pulse Current I_{PPM}	Max. Clamping Voltage $V_C@I_{PPM}$
		Min	Max					
Uni	Bi	(V)		(mA)	(V)	(μ A)	(A)	(V)
P4KE75A	P4KE75CA	71.30	78.80	1	64.10	1	4.00	103.0
P4KE82A	P4KE82CA	77.90	86.10	1	70.10	1	3.60	113.0
P4KE91A	P4KE91CA	86.50	95.50	1	77.80	1	3.30	125.0
P4KE100A	P4KE100CA	95.00	105.00	1	85.50	1	3.00	137.0
P4KE110A	-	105.00	116.00	1	94.00	1	2.70	152.0
-	P4KE110CA*	105.00	116.00	1	94.00	1	4.00	152.0
P4KE120A	-	114.00	126.00	1	102.00	1	2.50	165.0
-	P4KE120CA*	114.00	126.00	1	102.00	1	3.70	165.0
P4KE130A	-	124.00	137.00	1	111.00	1	2.30	179.0
-	P4KE130CA*	124.00	137.00	1	111.00	1	3.40	179.0
P4KE150A	-	143.00	158.00	1	128.00	1	2.00	207.0
-	P4KE150CA*	143.00	158.00	1	128.00	1	2.90	207.0
P4KE160A	-	152.00	168.00	1	136.00	1	1.90	219.0
-	P4KE160CA*	152.00	168.00	1	136.00	1	2.80	219.0
P4KE170A	-	162.00	179.00	1	145.00	1	1.80	234.0
-	P4KE170CA*	162.00	179.00	1	145.00	1	2.60	234.0
P4KE180A	-	171.00	189.00	1	154.00	1	1.70	246.0
-	P4KE180CA*	171.00	189.00	1	154.00	1	2.50	246.0
P4KE200A	-	190.00	210.00	1	171.00	1	1.50	274.0
-	P4KE200CA*	190.00	210.00	1	171.00	1	2.20	274.0
P4KE220A	-	209.00	231.00	1	185.00	1	1.30	328.0
-	P4KE220CA*	209.00	231.00	1	185.00	1	1.90	328.0
P4KE250A	-	237.00	263.00	1	214.00	1	1.20	344.0
-	P4KE250CA*	237.00	263.00	1	214.00	1	1.80	344.0
P4KE300A	-	285.00	315.00	1	256.00	1	1.00	414.0
-	P4KE300CA*	285.00	315.00	1	256.00	1	1.50	414.0
P4KE350A*	P4KE350CA*	332.00	368.00	1	300.00	1	1.30	482.0
P4KE400A*	P4KE400CA*	380.00	420.00	1	342.00	1	1.10	548.0
P4KE440A*	P4KE440CA*	418.00	462.00	1	376.00	1	1.00	602.0
P4KE480A*	P4KE480CA*	456.00	504.00	1	408.00	1	0.92	658.0
P4KE510A*	P4KE510CA*	485.00	535.00	1	434.00	1	0.86	698.0

TVS

TVS

TVS Diodes

Transient Voltage Suppression Diodes

SETsafe

SETfuse

P4KE Series

Part Number		Breakdown Voltage $V_{BR@I_T}$		Test Current I_T	Reverse Stand-off Voltage V_R	Max. Reverse Leakage $I_R@V_R$	Max. Peak Pulse Current I_{PPM}	Max. Clamping Voltage $V_C@I_{PPM}$
		Min	Max					
Uni	Bi	(V)		(mA)	(V)	(μ A)	(A)	(V)
P4KE530A*	P4KE530CA*	503.50	556.50	1	451.00	1	0.83	725.0
P4KE540A*	P4KE540CA*	513.00	567.00	1	460.00	1	0.82	740.0
P4KE550A*	P4KE550CA*	522.50	577.50	1	468.00	1	0.79	760.0

Notes:

1. Measured of 8.3 ms single half sine-wave or equivalent square wave, duty cycle=4 pulses per minute maximum.
2. $V_F < 3.5$ V for single die parts and $V_F < 5.0$ V for stacked-die parts.
3. For stacked die component details, please refer to models marked with * in electrical characteristics table.
4. For bidirectional type having V_R of 10 volts and less, the I_R should be doubled.

TVS

TVS

I-V Curve Characteristics

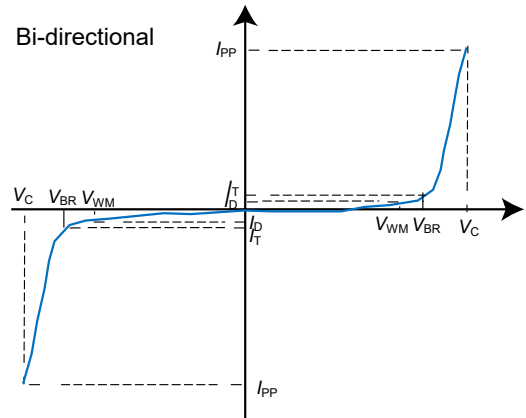
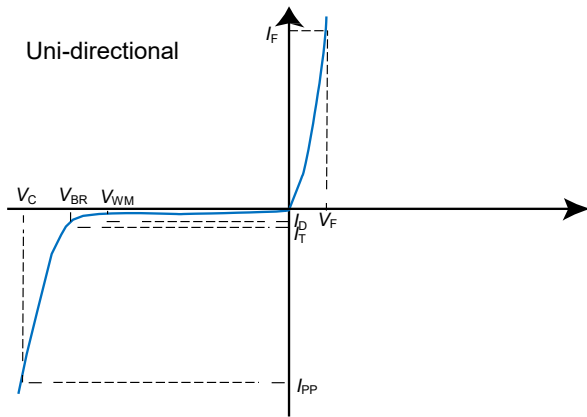

Performance Curve for Reference ($T_A=25^\circ\text{C}$ unless otherwise noted)

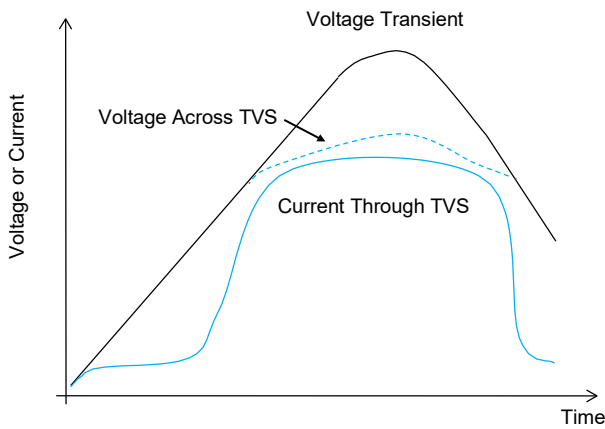

FIGURE 1 TVS Transients Clamping Waveform

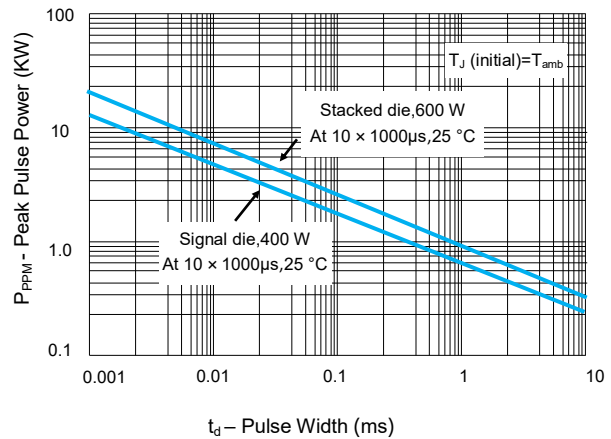

FIGURE 2 Peak Pulse Power Rating Curve

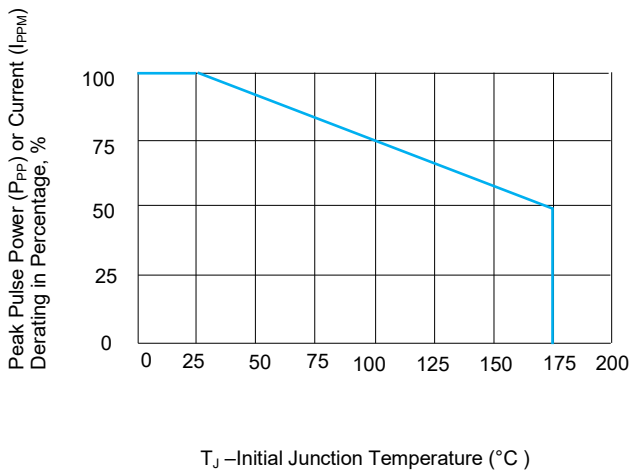

FIGURE 3 Peak Pulse Power Derating Curve

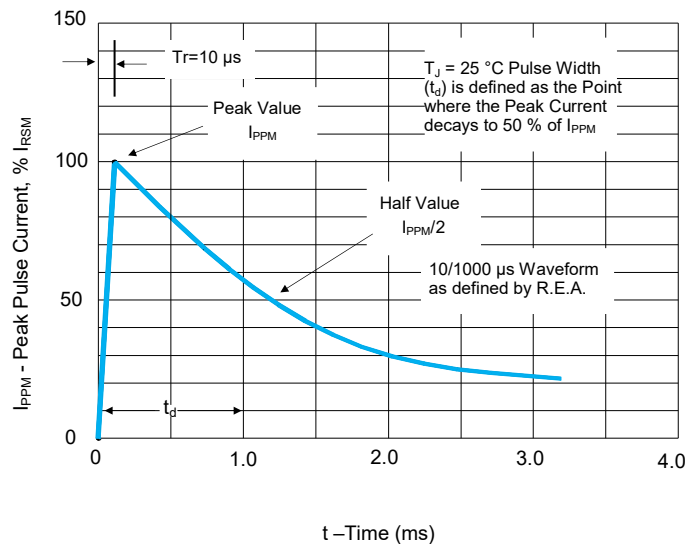

FIGURE 4 Pulse Waveform

TVS

TVS

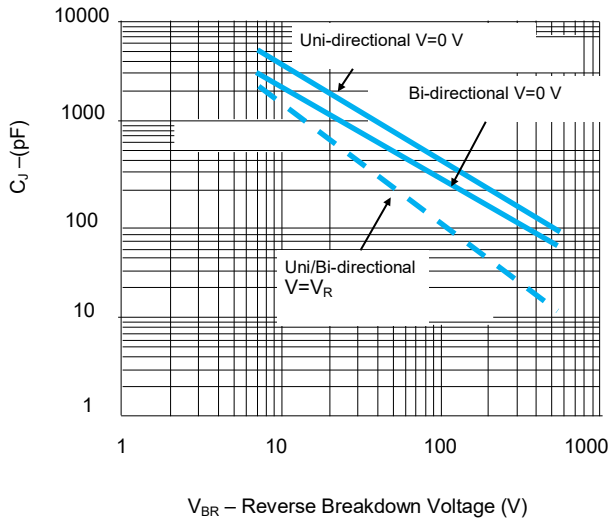

FIGURE 5 Typical Junction Capacitance

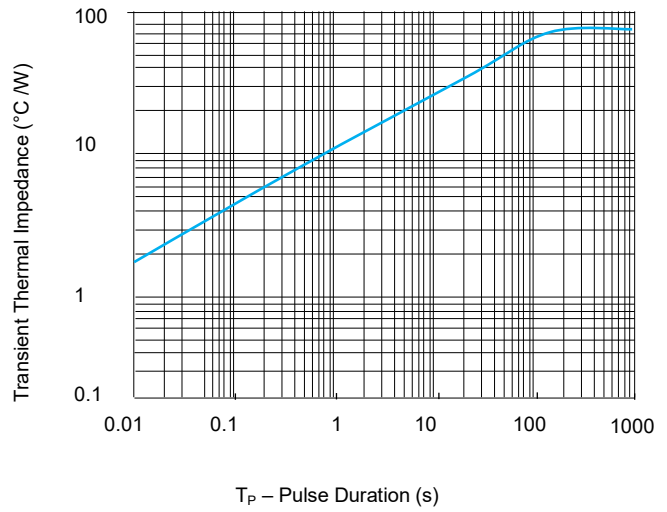

FIGURE 6 Typical Transient Thermal Impedance

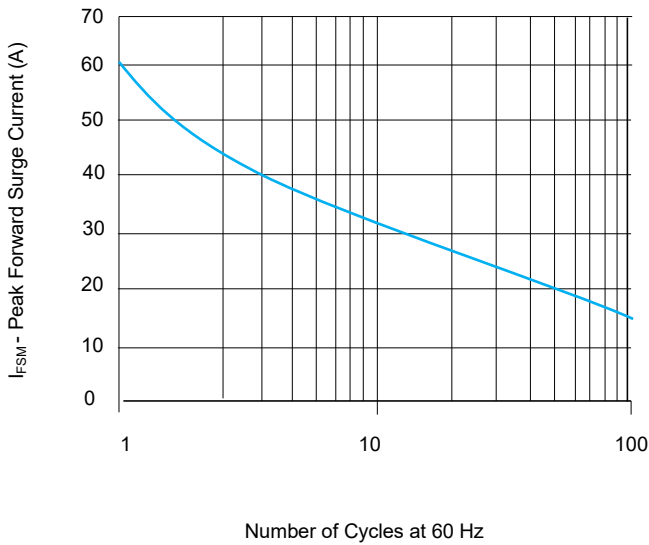

FIGURE 7 Maximum Non-Repetitive Forward Surge Current
Uni-Directional only

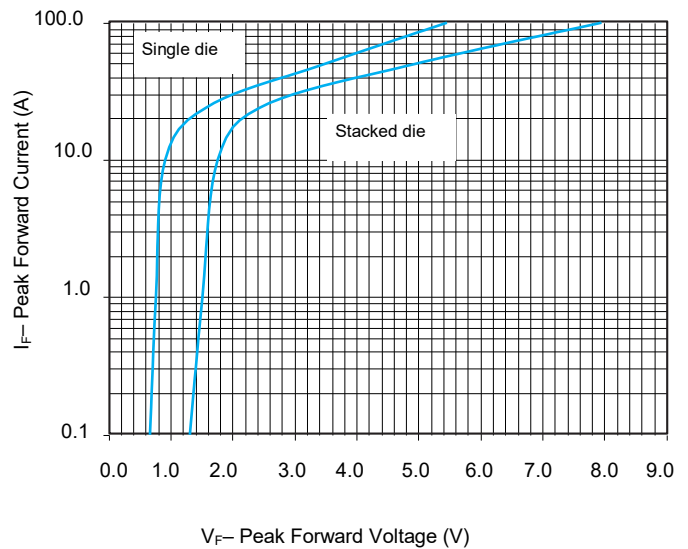

FIGURE 8 Peak Forward Drop vs Peak Forward Current
(Typical Values)

Environmental Specifications

High Temp. Storage	JESD22-A103
HTRB	JESD22-A108
Temperature Cycling	JESD22-A104
H3TRB	JESD22-A101
RSH	JESD22-B106

Physical Specifications

Weight	0.012 oz., 0.3 g
Case	JEDEC DO-204AL (DO-41) molded plastic body over passivated junction.
Polarity	Colored band indicates unidirectional component's cathode end
Terminal	Matte Tin-plated leads, solderability per JESD22-B102

Soldering Parameters

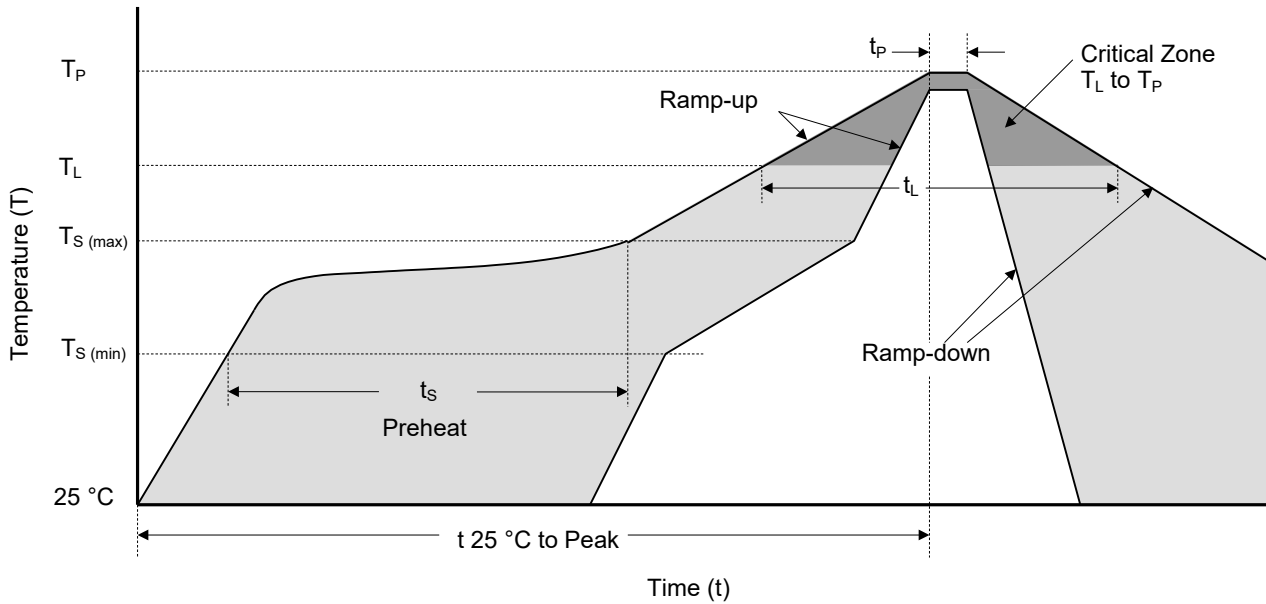

Reflowing Condition

Reflow Soldering Parameters		Lead-Free Assembly
Pre-heat	Temperature Min ($T_{S (min)}$)	150 °C
	Temperature Max ($T_{S (max)}$)	200 °C
	Time (min to max) (t_s)	60 ~ 120 seconds
Average Ramp Up Rate (Liquidus Temp (T_L) to Peak)		3 °C / second max.
$T_{S (max)}$ to T_L Ramp-up Rate		3 °C / second max.
Reflow	Temperature (T_L) (Liquidus)	217 °C
	Time (min to max) (t_L)	60 ~ 150 seconds
Peak Temperature (T_P)		260 ^{+0/-5} °C
Time of within 5 °C of Actual Peak Temperature (t_p)		20 ~ 40 seconds
Ramp-down Rate		6 °C / second max.
Time from 25 °C to Peak Temperature		8 Minutes max.
Do Not Exceed		260 °C

Flow/Wave Soldering (Solder Dipping)

Peak Temperature	260 °C+0 /- 5 °C
Dipping Time	10 seconds
Soldering Number	1 time

Packaging Information

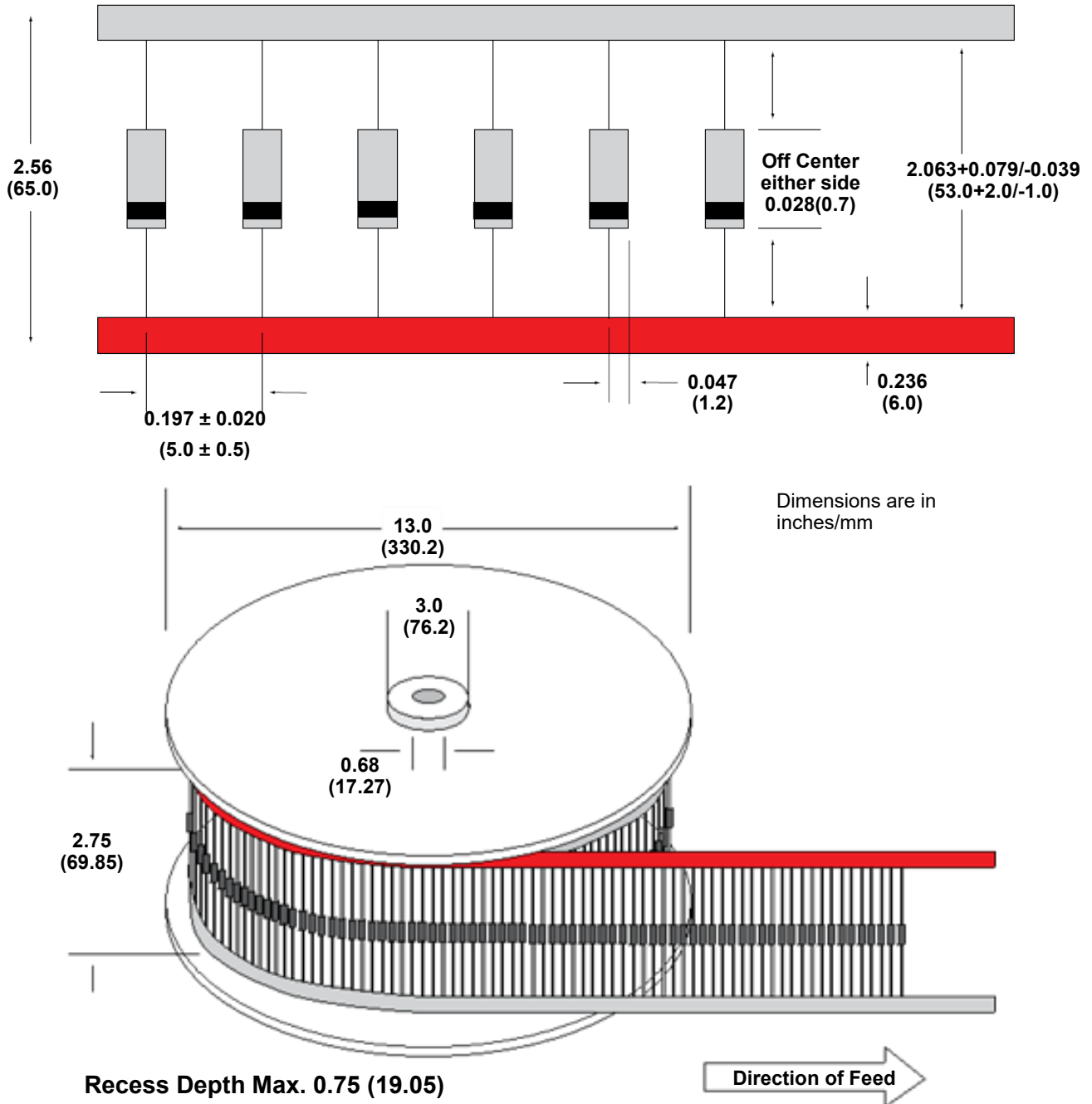

Part Number	Package	QTY' s (Reel)	Packaging Option	Packaging Specification
P4KExxxXX	DO-204AL	5000 PCS	Tape & Reel	EIA STD RS-296
P4KExxxXX-TB	DO-204AL	5000 PCS	TB	/
P4KExxxXX-B	DO-204AL	500 PCS	BOX	SETsafe SETfuse Spec



ATTENTION

Usage

1. TVS must be operated in the specified ambient temp.
2. Do not clean the TVS with strong polar solvent such as ketone, esters, benzene and halogenated hydrocarbon, to avoid damaging the encapsulating layer.
3. Please do not apply severe vibration, shock or pressure to TVS, to avoid element cracking.

Replacement

1. If TVS is visually damaged, please replace it.
2. TVS is a non-repairable product. For safety sake, please use equivalent TVS for replacement.

Storage

1. Storage Temp. Range: (-55 to 150) °C.
2. Do not store the TVS at the high temp., high humidity or corrosive gas environment, to avoid influencing the solder-ability of the lead wires. The product shall be used up within 1 year after receiving the goods.

Environmental Conditions

1. TVS should not be exposed to the open air, nor direct sunshine.
2. TVS should avoid rain, water vapor or other condition of high temp. and high humidity.
3. TVS should avoid sand dust, salt mist, or other harmful gases.

Max. Typical Capacitance of TVS

The typical capacitance of TVS is listed in the specifications. Designers may refer to it when designing TVS in High frequency circuit.

Installation Mechanical Stress

1. Do not knock TVS when installing, to avoid mechanical damage.
2. Please do not apply severe vibration, shock or pressure to TVS, to avoid surface resin or element cracking.