



## Description

SP0080SDT-3L TSS is a type of semiconductor component and specially provides dual line protection for RS485 application from damaging overvoltage transient events 6 kV / 3 kA @1.2 / 50  $\mu$ s - 8 / 20  $\mu$ s combination wave, 2  $\Omega$  .

This three pin modified DO214AB(SMC) solution provides a small footprint, lower component count and excellent clamping performance than traditional GDT and TVS combination solution.

## Pinout and Schematic Symbol

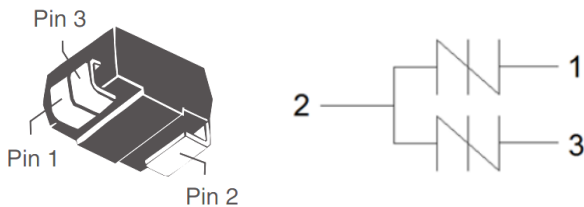

## Features

- Lower capacitance
- Low profile package
- Low on-state voltage
- Excellent capability of absorbing transient surge
- Quick response to surge voltage (ns Level)
- Eliminates overvoltage caused by fast rising transients
- Moisture sensitivity level: Level 1
- Non degenerative
- Flammability Rating: UL 94 V-0
- Halogen free and RoHS compliant

## Order Information

Type	Package	Marking Code	Delivery Form	Delivery Quantity
SP0080SDT-3L	SMC-3L	P08T	13" T&R	3000 PCS

## Limiting Values

(T<sub>A</sub> = 25 °C, unless otherwise specified)

Symbol	Parameter	Conditions	Min	Max	Unit
I <sub>PP</sub>	Repetitive peak pulse current	8 / 20 $\mu$ s <sup>1</sup>	3000	3450	A
T <sub>J</sub>	Operating Temperature Range	-	-40	125	°C
T <sub>stg</sub>	Storage Temperature Range	-	-55	150	°C

<sup>1</sup> Surge test in compliance with IEC61000-4-5, peak open circuit voltage waveform 1.2 / 50  $\mu$ s, peak short circuit current waveform 8 / 20  $\mu$ s@ 2  $\Omega$  combination wave.

### Electrical Characteristics

(T<sub>A</sub> = 25 °C, unless otherwise specified)

Part Number	T <sub>A</sub>	I <sub>DRM</sub> @V <sub>DRM</sub>		V <sub>S</sub> <sup>1</sup> @I <sub>S</sub>		V <sub>T</sub> @I <sub>T</sub>		I <sub>H</sub>	Capacitance <sup>2</sup>	
		μA	V	V	mA	V	A	mA	pF	
		max	Pin 1,3-2	Pin 1,3-2	-	max	-	min	min	max
SP0080SDT-3L	25 °C	5	6	15	800	4	2.2	50	400	700
	125 °C	20	6	15	800	4	2.2	35	400	700

<sup>1</sup> V<sub>S</sub> is measured at 100 kV / s.

<sup>2</sup> Off-state capacitance is measured in V<sub>DC</sub>=2 V, V<sub>RMS</sub>=1 V, f=1 MHz.

Symbol	Parameter
V <sub>DRM</sub>	Peak off-state voltage
I <sub>DRM</sub>	Off-state current
V <sub>S</sub>	Switching voltage
I <sub>S</sub>	Switching current
V <sub>T</sub>	On-state voltage
I <sub>T</sub>	On-state current
I <sub>H</sub>	Holding current
C <sub>O</sub>	Off-state capacitance

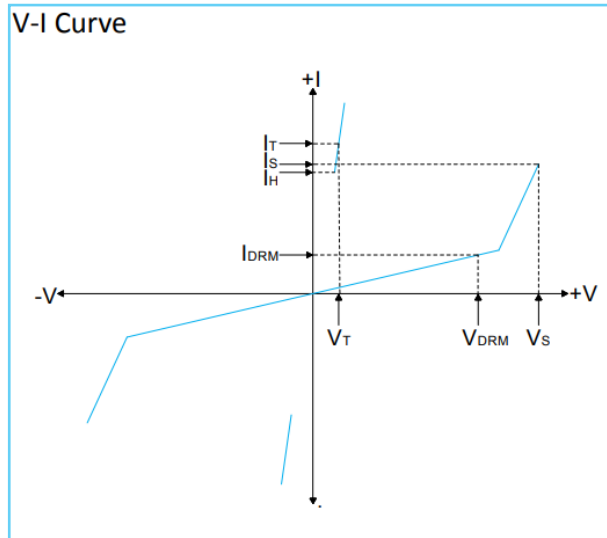

### Performance Curve for Reference

(T<sub>A</sub>=25 °C unless otherwise noted)

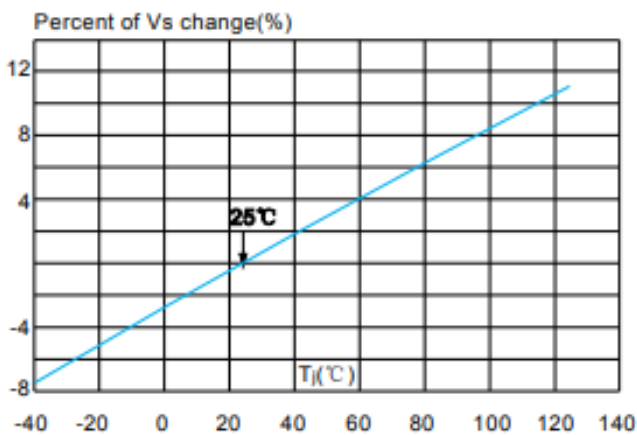

FIGURE 1

Normalized VS. Change VS. Junction Temperature

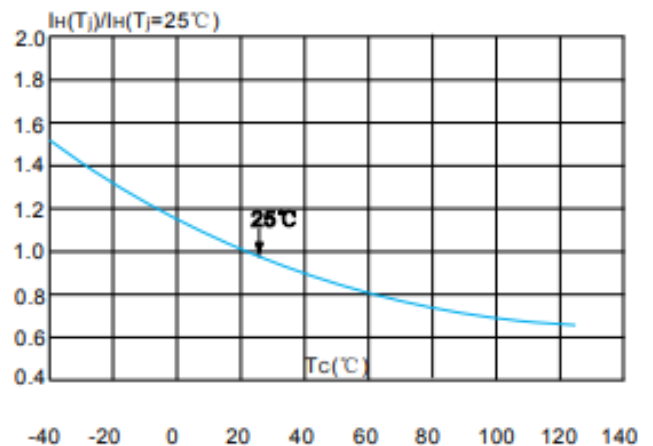
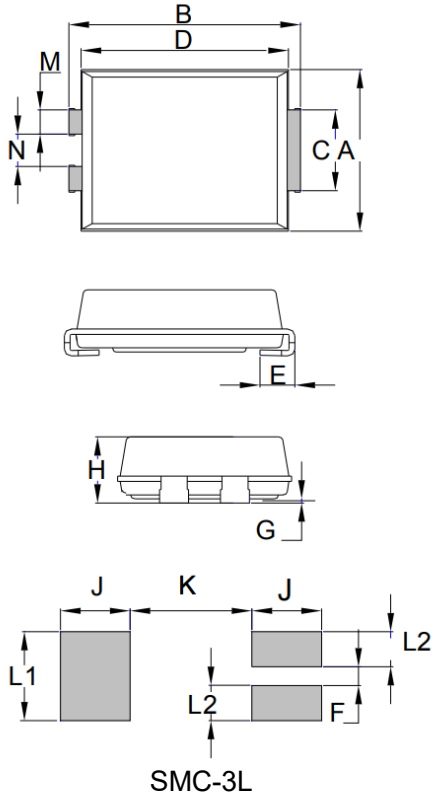

FIGURE 2

Normalized DC Holding Current VS. Case Temperature

Package Dimensions



Symbol	Millimeters		Inches	
	Min.	Max.	Min.	Max.
A	5.75	6.25	0.226	0.246
B	7.70	8.20	0.303	0.323
C	2.75	3.25	0.108	0.128
D	6.90	7.40	0.272	0.291
E	0.95	1.52	0.037	0.060
G	-	0.30	-	0.012
H	2.15	2.62	0.085	0.103
M	0.70	1.10	0.028	0.043
N	1.00	1.40	0.039	0.055
L2	1.30	-	0.051	-
F	0.70	-	0.028	-
J	2.40	-	0.094	-
K	-	4.20	-	0.165
L1	3.30	-	0.130	-

Part Numbering System

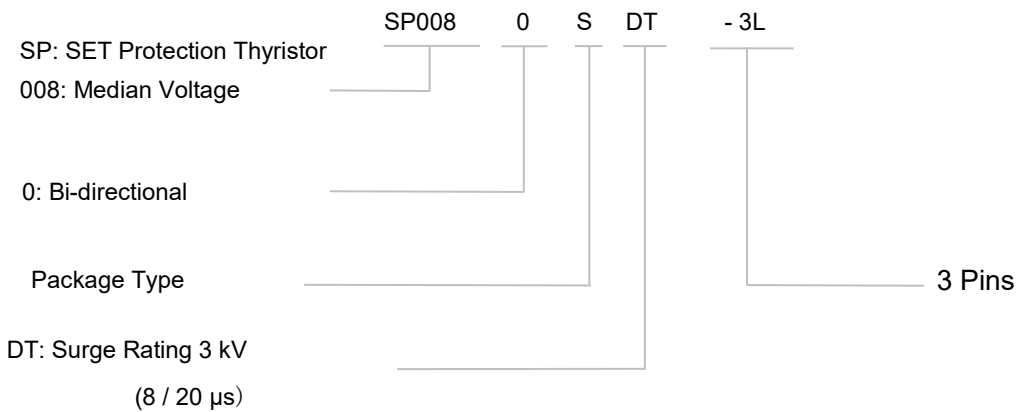

Marking

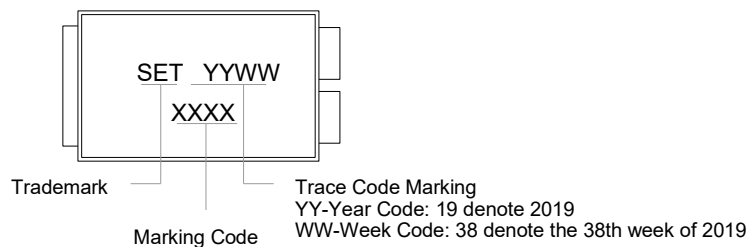

Packaging Information

Tape	Symbol	Dimension (mm)
	W	16.00 + 0.3 / -0.1
	P <sub>0</sub>	4.00 ± 0.10
	P <sub>1</sub>	8.00 ± 0.10
	P <sub>2</sub>	2.00 ± 0.10
	D <sub>0</sub>	1.55 ± 0.05
	D <sub>1</sub>	1.55 ± 0.05
	E	1.75 ± 0.10
	F	7.50 ± 0.10
	A <sub>0</sub>	6.15 ± 0.10
	B <sub>0</sub>	8.30 ± 0.10
	K <sub>0</sub>	2.48 ± 0.10
	T	0.30 ± 0.05

Reel Size	13" Reel	
	A	330 mm
	C	13.2 mm
	W <sub>1</sub>	12.5 mm

Part Number	Package	QTY (Reel)	Packaging Option	Packaging Specification
SP0080SDT-3L	SMC-3L	3000 PCS	Tape & Reel – 12mm tape/13" reel	EIA STD RS-481

### Soldering Parameters

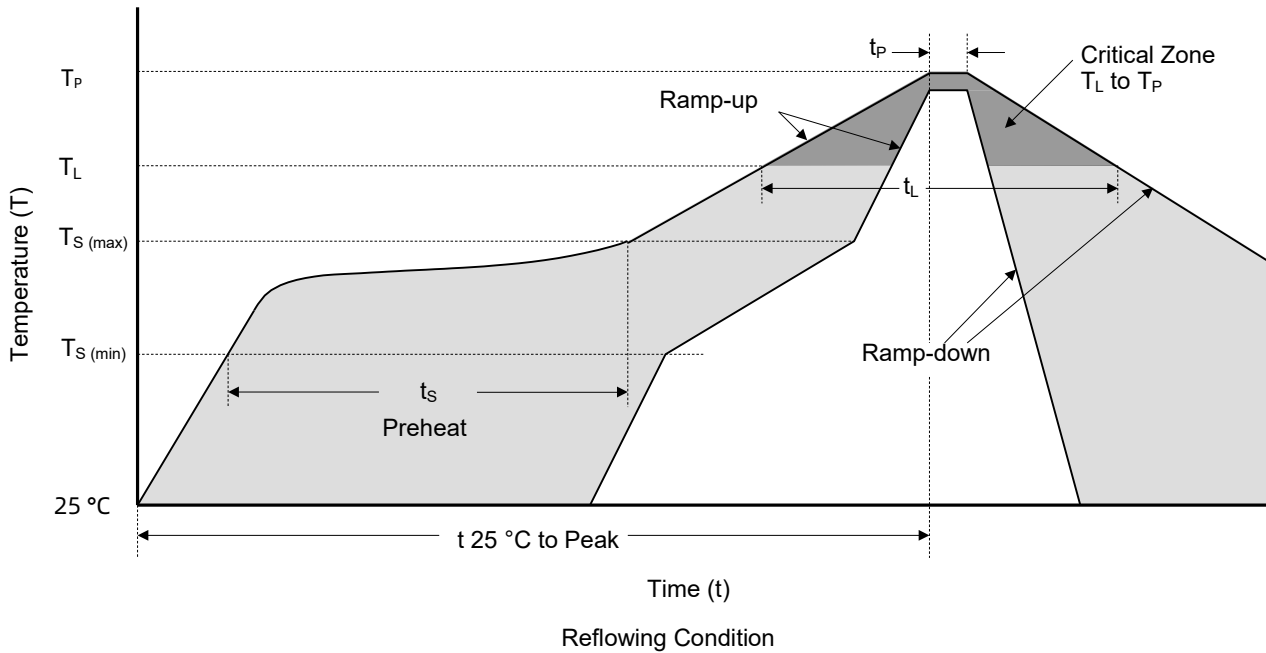

Reflow Soldering Parameters		Lead-Free Assembly
Pre-heat	Temperature Min ( $T_{S (min)}$ )	150 °C
	Temperature Max ( $T_{S (max)}$ )	200 °C
	Time (min to max) ( $t_s$ )	60 ~ 120 seconds
Average Ramp Up Rate ( Liquidus Temp ( $T_L$ ) to Peak Temp ( $T_P$ ))		3 °C / second max.
$T_s (max)$ to $T_L$ -Ramp-up Rate		3 °C / second max.
Reflow	Temperature ( $T_L$ )	217 °C
	Time ( $t_L$ )	60 ~ 150 seconds
Peak Temperature ( $T_P$ )		260 <sup>+0/-5</sup> °C
Time of within 5 °C of Actual Peak Temperature ( $t_p$ )		30 seconds
Ramp-down Rate		6 °C / second max.
Time From 25 °C to Peak Temperature		8 Minutes max.
Do Not Exceed		260 °C



# ATTENTION

## Usage

1. TSS must be operated in the specified ambient temp..
2. Do not clean the TSS with strong polar solvent such as ketone, esters, benzene and halogenated hydrocarbon, to avoid damaging the encapsulating layer.
3. Please do not apply severe vibration, shock or pressure to TSS, to avoid element cracking.

## Replacement

1. If TSS is visually damaged, please replace it.
2. TSS is a non-repairable product. For safety sake, please use equivalent TSS for replacement.

## Storage

1. Storage Temp. Range: (-55 to 150) °C.
2. Do not store the TSS at the high temp., high humidity or corrosive gas environment, to avoid influencing the solder- ability of the lead wires. The product shall be used up within 1 year after receiving the goods.

## Environmental Conditions

1. TSS should not be exposed to the open air, nor direct sunshine.
2. TSS should avoid rain, water vapor or other condition of high temp. and high humidity.
3. TSS should avoid sand dust, salt mist, or other harmful gases.

## Max. Typical Capacitance of TSS

1. The typical capacitance of TSS is listed in the specifications. Designers may refer to it when designing TSS in High frequency circuit.

## Installation Mechanical Stress

1. Do not knock TSS when installing, to avoid mechanical damage.
2. Please do not apply severe vibration, shock or pressure to TSS, to avoid surface resin or element cracking.