

TRXF

Thermal-Link & Fusing Resistor

TRXF1 Series

Vertical Installation (Round)

Dimensions (mm)

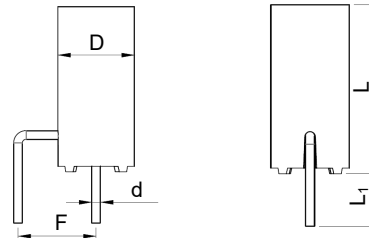

L	L ₁ ^a	D	d	F ^a
11.0 Max.	3.5 ± 0.5	Φ4.8 ± 0.2	Φ0.54 ± 0.05	5.0 ± 0.5

Note:

a: F, L₁ and the bending mode of pins can be customized as required.

Horizontal Installation (Ω Shape)

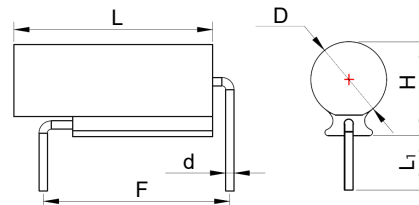

L	L ₁ ^a	H	D	d	F ^a
11.0 Max.	3.5 ± 0.5	6.0 ± 0.2	Φ4.8 ± 0.2	Φ0.54 ± 0.05	10.0 ± 0.5

Note:

a: F, L₁ and the bending mode of pins can be customized as required.

Description

Thermal-Link & Fusing Resistor (TRXF) is a unique type of power resistor, with over temp. and over current protections. The Alloy Thermal-Link (ATCO) is placed through the core of Fusible Wirewound Resistor (RXF) and in series with RXF.

Features

- Patented Product
- Over Temp. Protection
- Surge Protection
- Inrush Current Protection
- Small Fault Current Protection
- Short Circuit Protection
- RoHS & REACH Compliant



Applications

- Switch Mode Power Supply (SMPS)
- Adapters
- LED Drivers
- Small Power Home Appliances

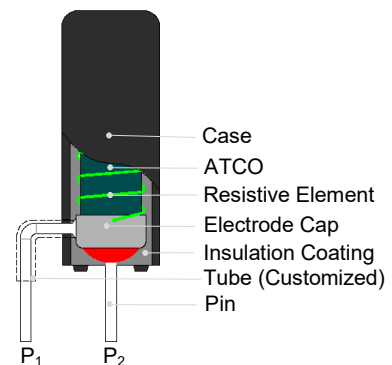
Structure Diagram



Agency Approvals

Agency	Standards	File No.	Resistance Range
 US E324712	UL1412	E324712	0.27 Ω ~ 800 Ω
 V019518	SJ 2865	CQC15001126563	0.27 Ω ~ 800 Ω
	IEC 60065	R50279979	0.47 Ω ~ 800 Ω

Technical Parameter

Item	Parameter
Power Type (P)	1 W
Rated Resistance (R)	1 Ω ~ 800 Ω
Resistance Tolerance	5% (E24) , 10% (E12)
Derating Factor (f)	See Rated Power Derating Curve
Actual Power (P ₀)	$P_0 = P \times f$
Rated Current (I _N)	$I_N = \sqrt{P_0 / R}$
Rated Voltage (U _N)	$U_N = \sqrt{P_0 \times R}$
Fusing Time (less than 60 seconds)	5 × P (T _f = 221 °C)
	3 × P (T _f = 145 °C)
Fusing Temp.	216 °C to 221 °C (T _f = 221 °C)
	138 °C to 142 °C (T _f = 145 °C)
Surge	2.0 kV (R > 10 Ω)
	1.0 kV (R ≤ 10 Ω)

Part Numbering System

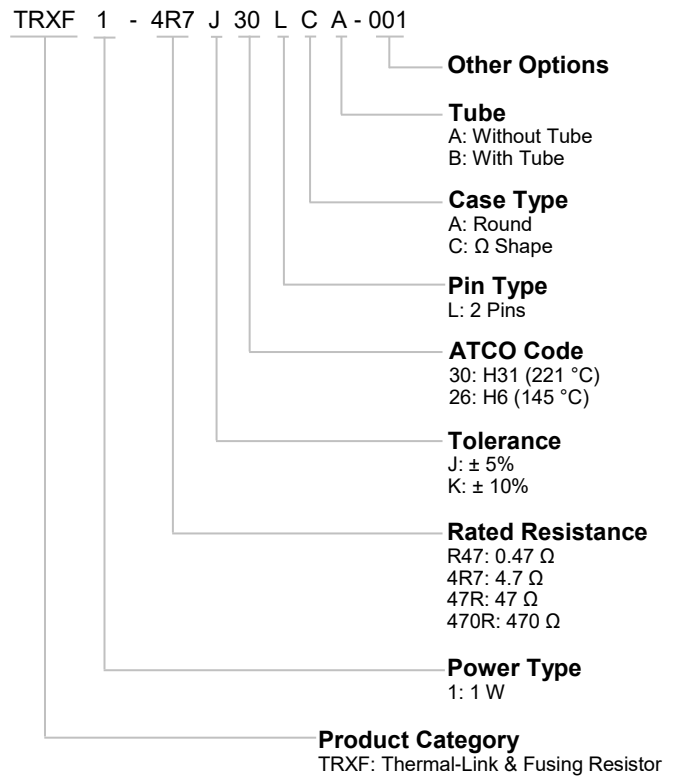

Rated Power Derating Curve (For Reference Only)

When the ambient temp. exceeds 25 °C, the rated power value declines as the following curve.

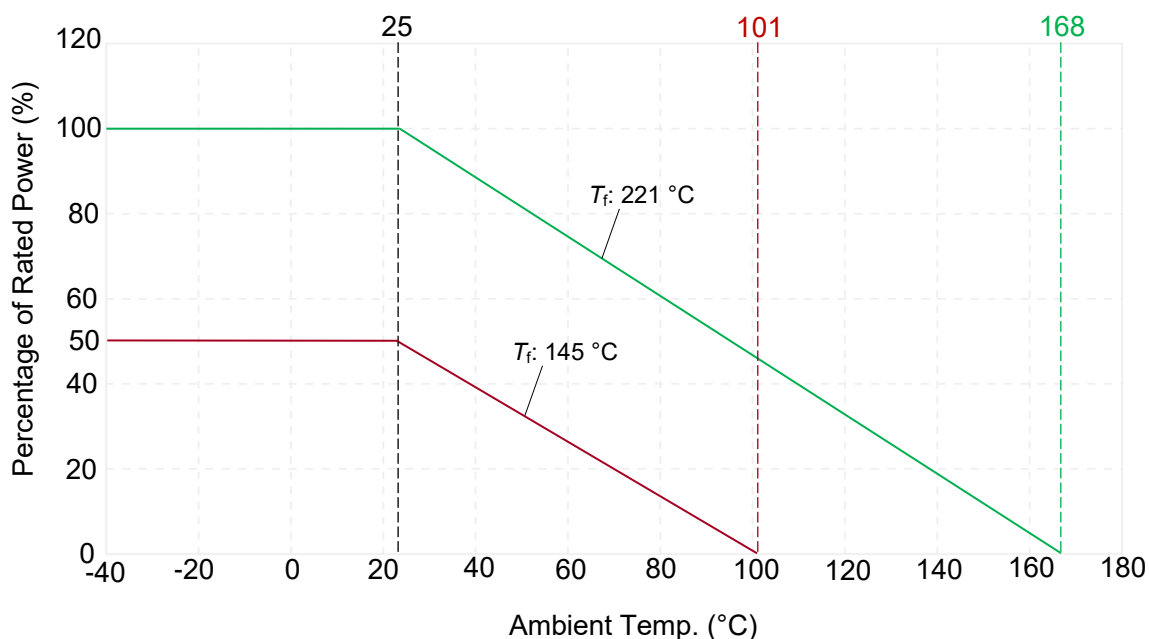

Glossary

Item	Description
RXF	Fusible Wirewound Resistor A power resistor which is made by winding a resistive element on a ceramic core, and the core is coated by insulation coating. It intends to interrupt a current flow at a predetermined time when the current exceeds a predetermined value.
ATCO	Alloy Thermal-Link Alloy Type Thermal-Link, alloy is the thermal element. Thermal-Link is a non-resettable device incorporating a THERMAL ELEMENT which will open a circuit once only when exposed for a sufficient length of time to a temp. in excess of that for which it has been designed.
R	Rated Resistance Resistance value for which the resistor has been designed, and which is generally used for denomination of the resistor.
P₀	The Max. power of TRXF can be used within the allowable operating temp. range.
I_N	Rated Current $I_N = \sqrt{P_0 / R}$
U_N	Rated Voltage The d.c. or a.c. r.m.s. voltage calculated from the square root of the product of the rated resistance and the rated dissipation.
Fusing Temp.	Fusing Temp. The temp. of the TRXF which causes it to change its state of conductivity is measured with silicone oil bath in which the temp. is increased at the rate of 0.3 °C/min to 0.5 °C/min, with a detection current up to 10 mA as the only load.
T_f	Rated Functioning Temp. The temp. of the Thermal-Link which causes it to change its state of conductivity with a detection current up to 10 mA as the only load.
TCR	Temp. Coefficient of Resistance Relative variation of resistance between two given temp. divided by the difference in the temp. producing it.

Marking

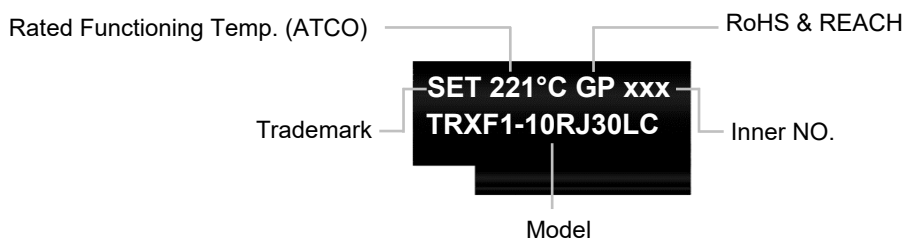



TRXF

Thermal-Link & Fusing Resistor

TRXF1 Series

Specifications

Series	Power Type	Derating Factor (25 °C)	Rated Resistance	Resistance Tolerance	Rated Functioning Temp. (T _f)	Fusing Temp.	Agency Approvals			Environmental Status	
										RoHS	REACH
							cURus	TUV	CQC		
(W)	(%)	(Ω)	(%)	(°C)	(°C)						
TRXF1	1	50	0.27 ~ 0.47	± 5, ± 10	145	138 ~ 142	●	N/A	●	●	●
		100			221	216 ~ 221	●	●	●	●	
		50	0.47 ~ 800	± 5, ± 10	145	138 ~ 142	●	●	●	●	●
		100			221	216 ~ 221	●	●	●	●	

Resistance Selection Table (According to IEC60063-2015, blue font is SETsafe | SETfuse common resistance).

Rated Resistance	Code	Rated Resistance	Code	Rated Resistance	Code	Rated Resistance	Code
(Ω)		(Ω)		(Ω)		(Ω)	
0.10	R10	1.0	1R0	10	10R	100	100R
0.11	R11	1.1	1R1	11	11R	110	110R
0.12	R12	1.2	1R2	12	12R	120	120R
0.13	R13	1.3	1R3	13	13R	130	130R
0.15	R15	1.5	1R5	15	15R	150	150R
0.16	R16	1.6	1R6	16	16R	160	160R
0.18	R18	1.8	1R8	18	18R	180	180R
0.20	R20	2.0	2R0	20	20R	200	200R
0.22	R22	2.2	2R2	22	22R	220	220R
0.24	R24	2.4	2R4	24	24R	240	240R
0.27	R27	2.7	2R7	27	27R	270	270R
0.30	R30	3.0	3R0	30	30R	300	300R
0.33	R33	3.3	3R3	33	33R	330	330R
0.36	R36	3.6	3R6	36	36R	360	360R
0.39	R39	3.9	3R9	39	39R	390	390R
0.43	R43	4.3	4R3	43	43R	430	430R
0.47	R47	4.7	4R7	47	47R	470	470R
0.51	R51	5.1	5R1	51	51R	510	510R
0.56	R56	5.6	5R6	56	56R	560	560R
0.62	R62	6.2	6R2	62	62R	620	620R
0.68	R68	6.8	6R8	68	68R	680	680R
0.75	R75	7.5	7R5	75	75R	750	750R
0.82	R82	8.2	8R2	82	82R	N/A	N/A
0.91	R91	9.1	9R1	91	91R	N/A	N/A

Fusing Time Curve (For Reference Only)

TRXF can open effectively at lower power multiples to protect the circuit timely (ambient temp. 25 °C ± 2 °C).

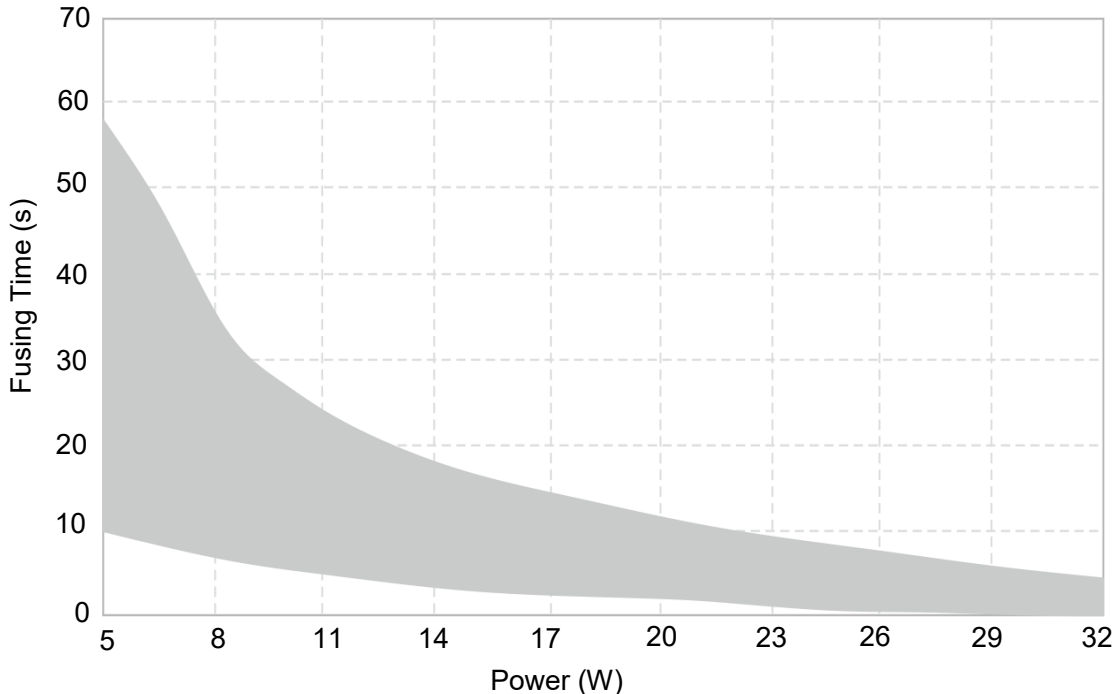

Surface Temp. Curve (For Reference Only)

The surface temp. of TRXF is always at a lower level, when small fault current happens to the device, TRXF is able to open the circuit timely without additional damage (ambient temp. 25 °C ± 2 °C).

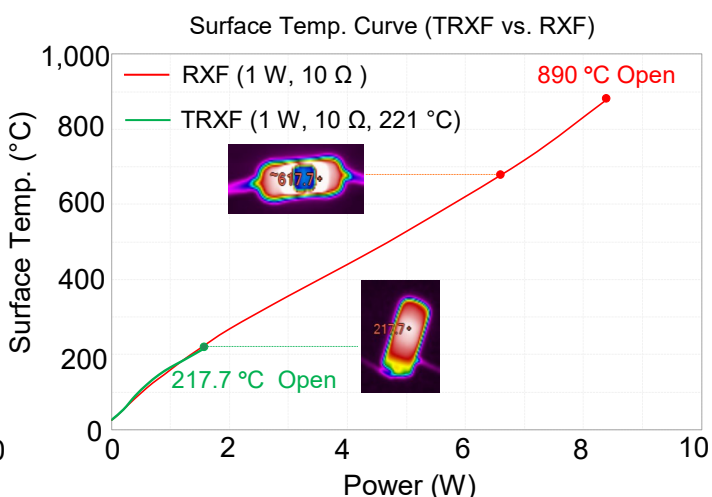
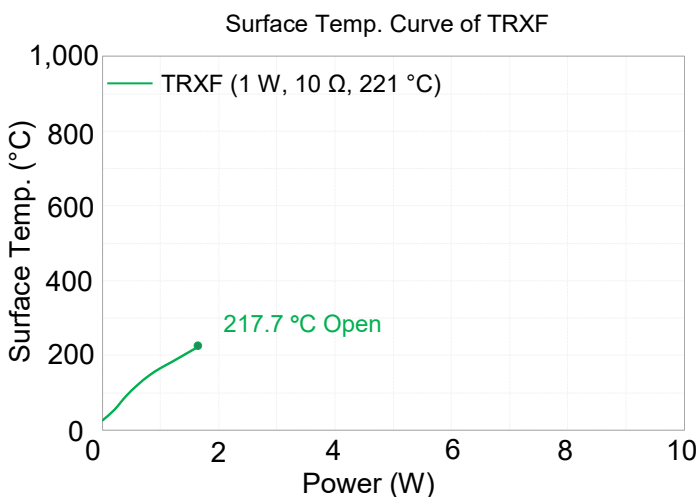

Operating Principle

Instruction

$$R_{RXF} \geq 100R_{ATCO}$$

- R_{RXF} : the resistance value of RXF
- R_{ATCO} : the resistance value of ATCO

$$T_{RXF} \geq 5T_{ATCO}$$

- The Fusing Temp. of RXF (T_{RXF}): 1,200 °C ~ 1,500 °C
- The Fusing Temp. of ATCO (T_{ATCO}): 145 °C ~ 221 °C

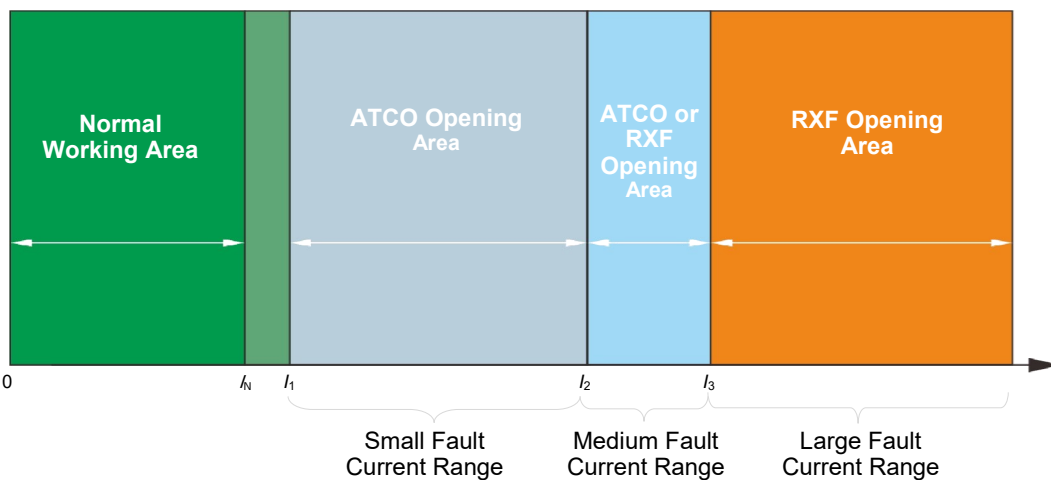
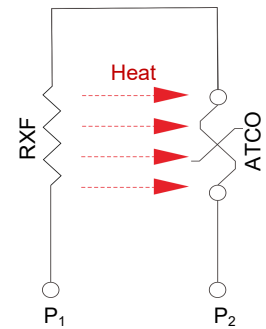

I_N : Rated Current

I_1 : Conventional Fusing Current

● Small Fault Current Protection

At small fault current, $I_1 < I < I_2$, ATCO senses the heat that generated by RXF, when the ATCO reaches the fusing temp., ATCO opens the circuit quickly. In this case, RXF keeps intact and ATCO opens.

● Medium Fault Current Protection

At medium fault current, $I_2 < I < I_3$, RXF opens in a short time because of much heat generated, meanwhile, RXF conducts its residual heat to ATCO. In this case, both RXF and ATCO open.

● Large Fault Current Protection (Short Circuit Protection)

At large fault current, such as short circuit, $I > I_3$, RXF opens instantly but ATCO keeps intact because the fusing time of RXF is too short to generate enough heat. In this case, RXF opens and ATCO keeps intact.

Performance Test

Mechanical Performance Test

Item	Test Condition	Criterion
Tensile Test	A pin withstand 10 N × 60 seconds	No Visible Damage $\Delta R \leq \pm (1\%R + 0.05 \Omega)$
Twist Test	A pin 2 mm away from body, bent 90°, twist 180° × 2 times	No Visible Damage $\Delta R \leq \pm (1\%R + 0.05 \Omega)$

Environmental Test

Item	Test Condition	Criterion
Temp. Cycle	1. - 55 °C × 30 minutes 2. Room Temp. × (10 to 15) minutes 3. 85 °C × 30 minutes 4. Room Temp. × (10 to 15) minutes 5. 5 Cycles from Step 1 to Step 4	$\Delta R \leq \pm (2\%R + 0.05 \Omega)$

Electrical Performance Test

Item	Test Condition	Criterion
TCR	$TCR = \frac{(R_2 - R_1)}{R_1 (T_2 - T_1)} \times 10^6$ R ₁ : Resistance Value at 25 °C R ₂ : Resistance Value at 125 °C	Within Specified Value
Short-Time Overload	2.5U _N × 5 seconds	No Visible Damage $\Delta R \leq \pm (2\%R + 0.05 \Omega)$
Insulation Resistance	Foil Method: Apply 500 VDC between both terminations of the resistor connected together as one pole and the metal foil as the other pole.	Insulation Resistance ≥ 1,000 MΩ
Voltage Proof	Foil Method: Apply 900 VAC × 1 min between terminations and the metal foil.	No Breakdown or Flashover
Fusing Test	Apply test current to the resistor (constant current source).	Fusing Time ≤ 60 seconds
Solderability	Solder Bath (non-activated flux) Soldering Powder: 25% Rosin Alcohol Bath Temp.: (255 ± 5) °C Depth of Immersion (From the seating plane or component body): (1.5 to 2.0) mm Time of Immersion: (2.5 ± 0.5) seconds	Soldering Area ≥ 95%
Short Circuit Test	Fusing resistor at both terminals of the test voltage is applied directly.	No Obvious Explosion Sound or Electronic Spark
Surge Test	Combination Wave Generator (1.2/50 μs, 8/20 μs, 2 Ω), apply open-circuit voltage 1.0 kV (R ≤ 10 Ω) or 2.0 kV (R > 10 Ω) to the resistor, 10 pulses test at 1 minute Interval.	Resistor shall not open after the test
Fusing Temp.	Silicone oil bath: temp. rise rate is 0.3 °C/min to 0.5 °C/min, detection current ≤ 10 mA.	216 °C to 221 °C (T _f = 221 °C) 138 °C to 142 °C (T _f = 145 °C)

Wave Soldering Parameters (For Reference Only)

The Wave Soldering Parameters are for reference only, before TRXF is for practice usage, relative validation is recommended.

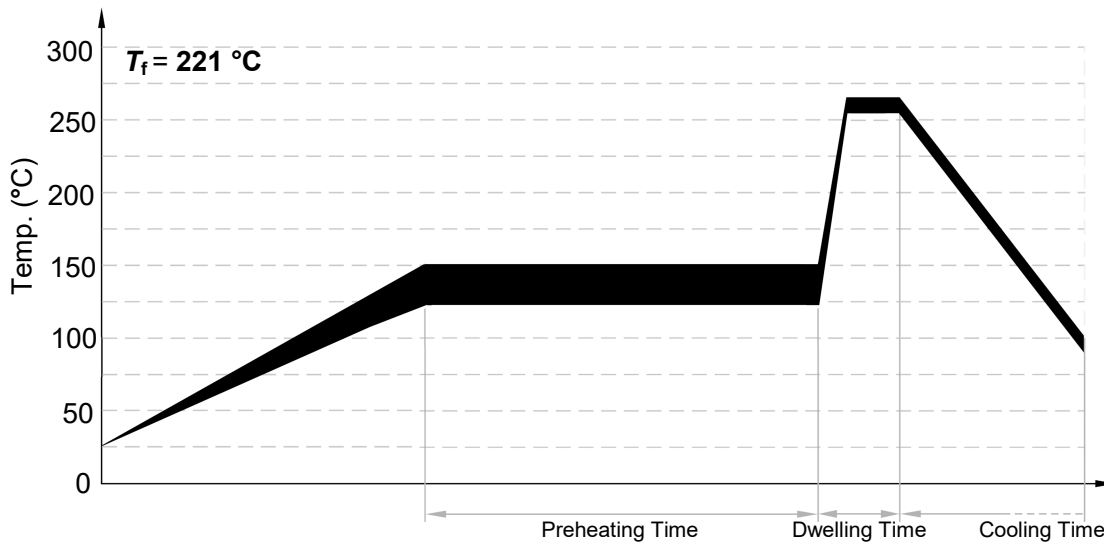
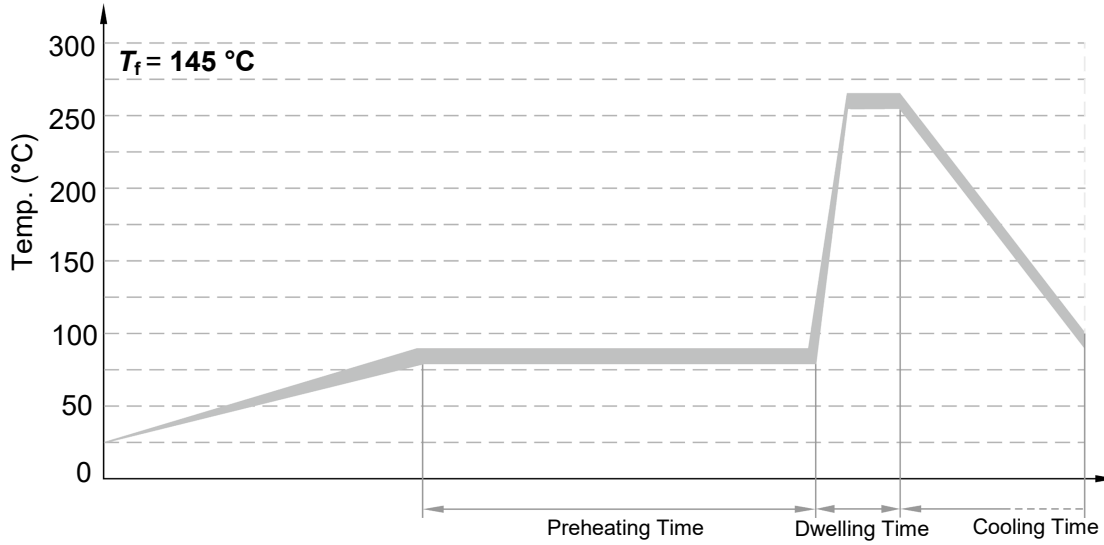

Item	Temp. (°C)		Time (s)
	$T_f=145\text{ °C}$	$T_f=221\text{ °C}$	
Preheating	80 ~ 90	120 ~ 150	60 ~ 100
	260 ± 5	260 ± 5	
Dwelling	260 ± 5	260 ± 5	4 ~ 5

Recommended Hand-Soldering Parameters

Solder Iron Temp.: (350 ± 5) °C

Soldering Time: 2 s Max. (115 °C ≤ T_f ≤ 150 °C)

3 s Max. ($T_f = 221\text{ °C}$)

TRXF

Thermal-Link & Fusing Resistor

TRXF1 Series

Packaging Information

Taping

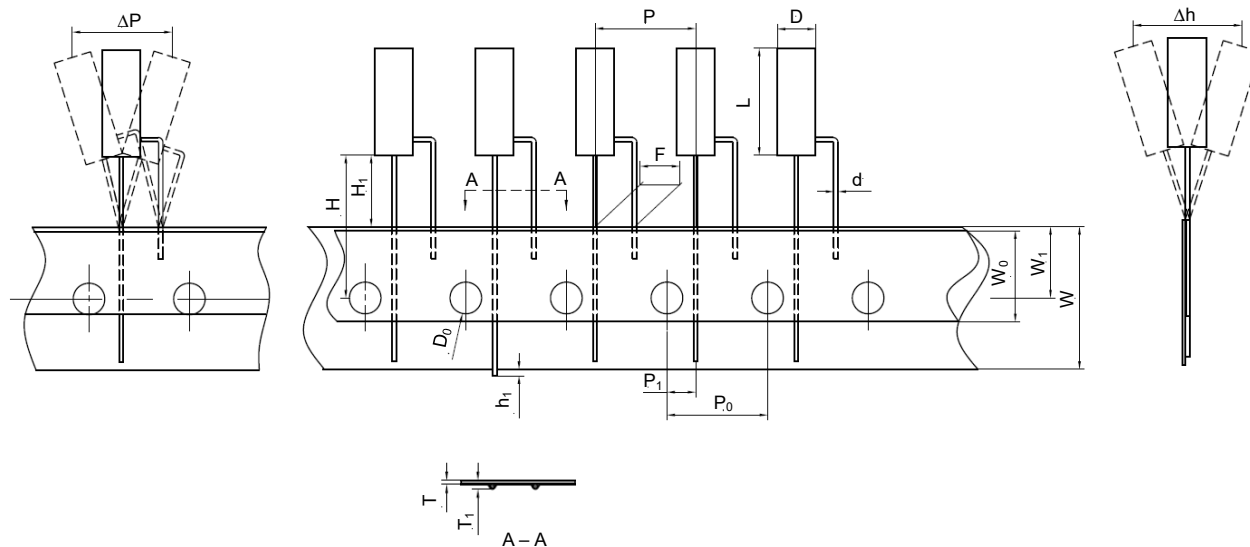

H	H ₁	h ₁	Δh	F	P	P ₀	P ₁	Δp	D ₀	D	d	W	W ₀	W ₁	T	T ₁	L
18.0 ± 0.5	9.0 ± 0.5	0.5 Max.	2.0 Max.	5.0 ± 0.5	12.7 ± 0.5	12.7 ± 0.5	3.9 ± 0.5	2.0 Max.	4.0 ± 0.3	4.8 ± 0.2	0.54 ± 0.05	18.0 ± 0.2	12.0 ± 0.2	9.0 ± 0.2	0.7 Max.	1.5 Max.	11 Max.

Item	Box	Carton
Dimensions (mm)	340 × 205 × 45	520 × 360 × 230
Quantity (PCS)	2,000	20,000
Gross Weight (kg)		15 ± 10%

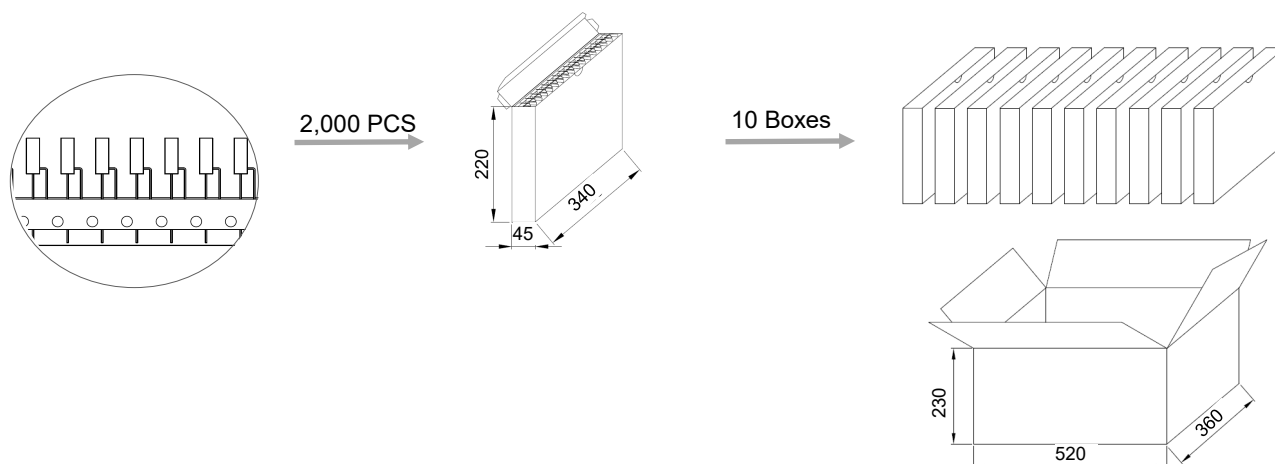

TRXF

Thermal-Link & Fusing Resistor

TRXF1 Series

Packaging Information

Bulk

Item	PE Bag	Tray	Carton
Dimensions (mm)	135 × 85	475 × 315 × 24.5	495 × 330 × 230
Quantity (PCS)	100	2,000	20,000
Gross Weight (Vertical Installation) (kg)			10.5 ± 10%
Gross Weight (Horizontal Installation) (kg)			12.0 ± 10%

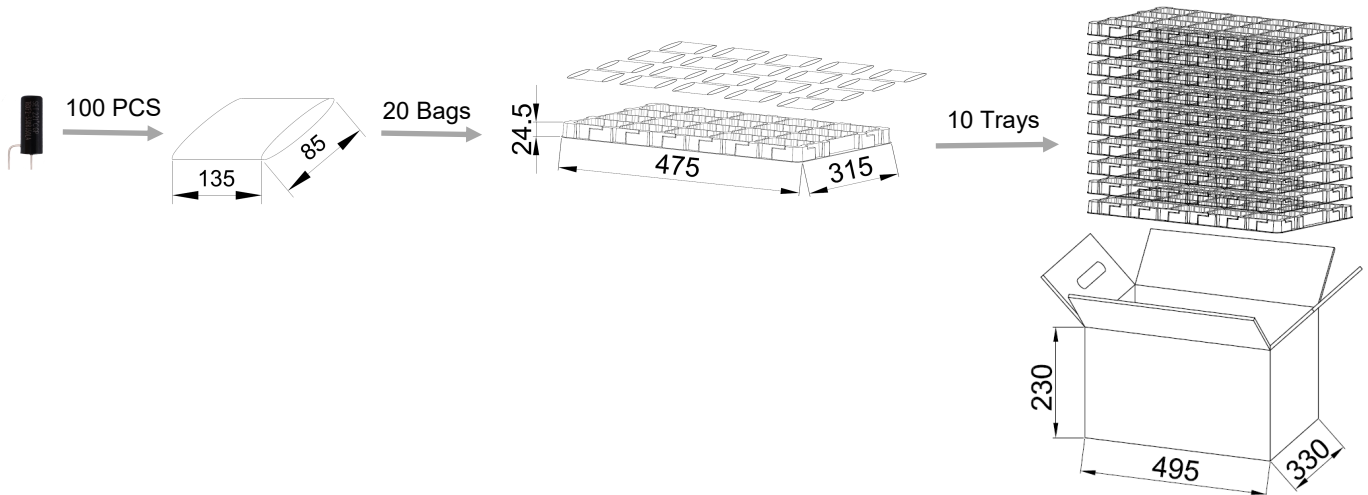

TRXF

TRXF



ATTENTION

Cold Resistance Test

1. If product TCR is not less than $350 (10^{-6}/^{\circ}\text{C})$, the measured resistance value shall be corrected as the relative resistance value under 25°C according to TCR formula.
2. Resistance Measurement (4-terminal test).

Replacement

As TRXF is a non-resettable product, for safety sake, please use the same type of TRXF for replacement.

Usage

1. Do not touch the resistor body or pins directly when power is on, to avoid burn or electric shock.
2. When air pressure is from 80 kPa to 106 kPa, the relative altitude shall be +2000 m to - 500 m.

Storage

1. Please store TRXF with ambient temp. $10^{\circ}\text{C} \sim 30^{\circ}\text{C}$ and relative humidity 30% ~ 75%.
2. Do not store the TRXF at the high temp., high humidity or corrosive gas environment, avoid influencing the solderability of the pins, please use them up within 1 year after receiving the goods.