



Description

Metal Oxide Varistor (MOV) as one nonlinear resistance element is mainly made of zinc oxide (ZnO), which has very high surge capacity and big nonlinear coefficient. Below the threshold voltage, its resistance is very high, nearly no current flows through, but above the threshold voltage, the resistance reduces sharply, huge current can be discharged. Due to this characteristic, varistor as a protection component in electronic and electrical equipment can absorb abnormal over-voltage and lightning surge.

SETsafe | SETfuse varistor is with High Surge Current Density, Low Clamping Voltage, and Good Surge Capacity. It can also be customized as required.

Features

- Epoxy Resin Coating
- Silicone Resin Coating
- Low Leakage Current
- Bidirectional and Symmetrical V/I Characteristics
- RoHS & REACH Compliant
- Operating Temperature Range
Low Temperature: -40 °C
High Temperature: +85 °C

Applications

- Power Supplies
- Home Electrical Appliances
- Industrial Devices
- Surge Protectors
- Telecom Devices

Product Structure

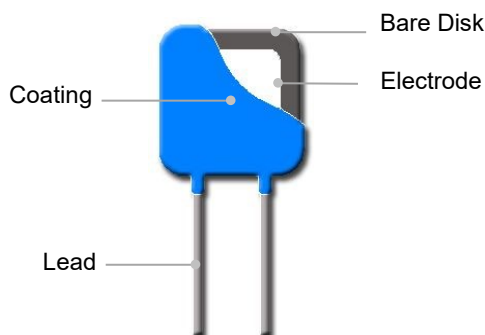

Lead Types

Lead Types		Codes
	Straight Lead	A
	Inward Crimp Lead	B
	Outward Crimp Lead	C
	Inline Crimp Lead	D

Agency Approvals

Agency	Standards	No.
	UL 1449 4 th Edition	E322662
	CSA C22.2 NO.269.5-17	E322662
	EN 61051-1:2008 IEC 61051-1:2007 IEC 61051-2:1991 IEC 61051-2-2:1991	J 50239738

MOV

MOV

Marking

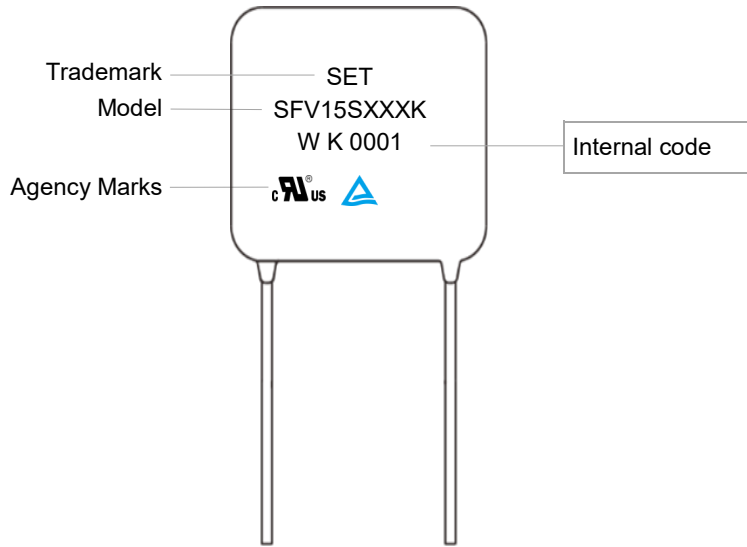

Temp. Derating Curve

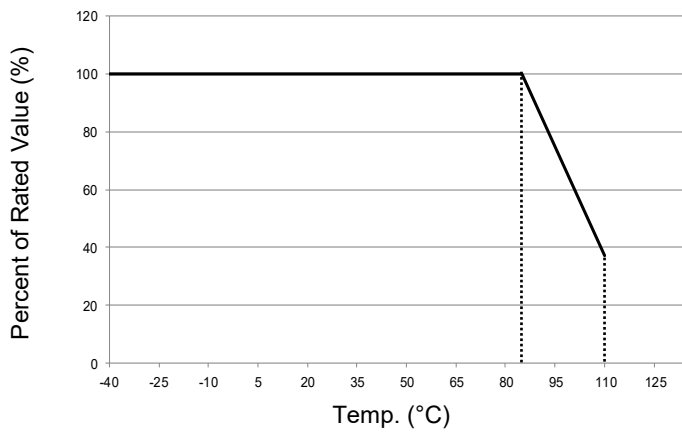

Note:

When ambient Temp. exceeds 85 °C, the peak surge current and energy rating should be reduced as shown in the left curve.

For Normal Temp. Series

General Technical Data

Item	Value	Unit
Operating Temperature	-40 to +85	°C
Storage Temperature	-40 to +125	°C
Voltage Proof	≥2500	V _{ac}
Insulation Resistance	≥100	MΩ

Part Numbering System

SFV 15 S 471 - K N K A BUL - 001

MOV

MOV

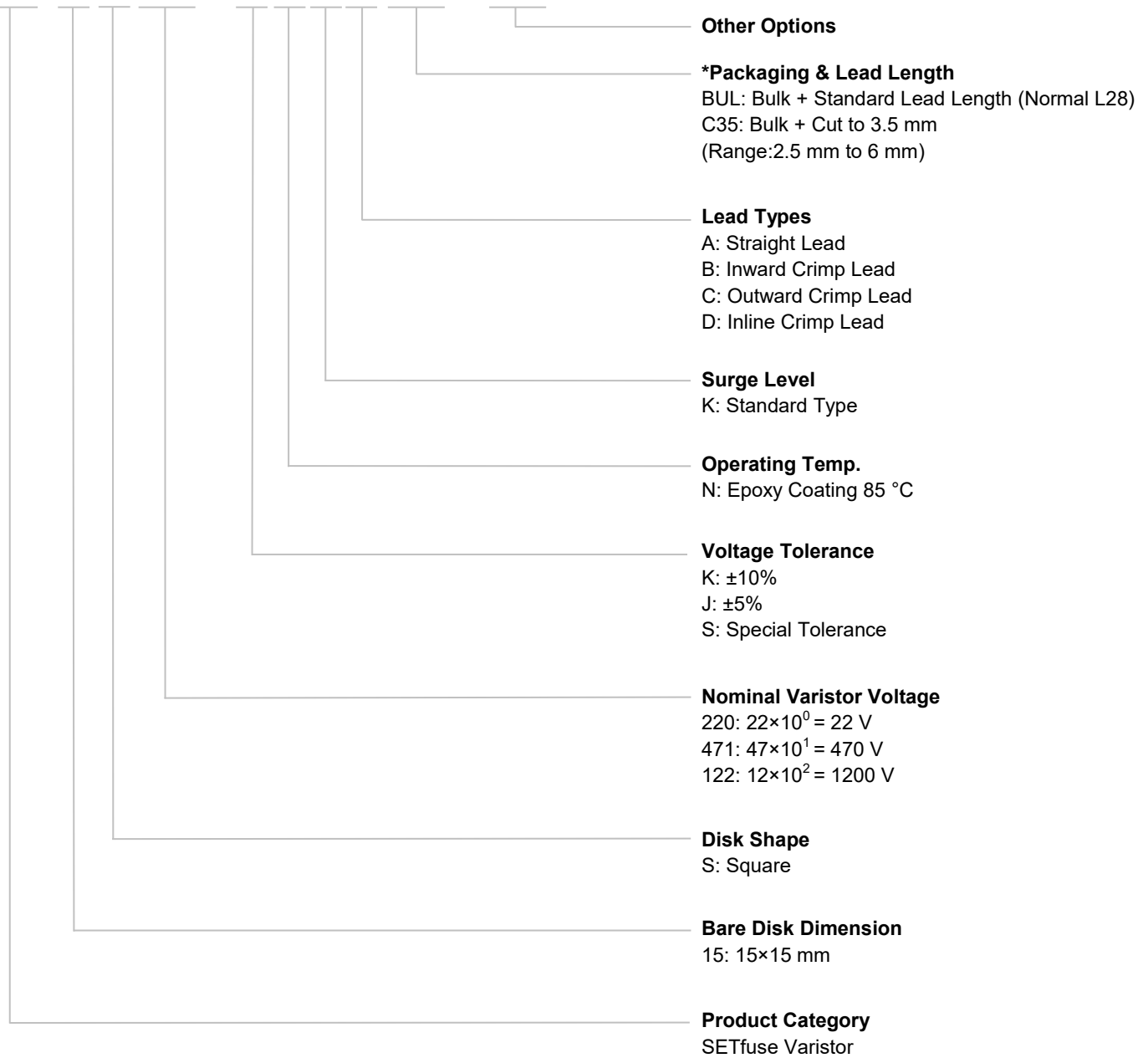

*For more details refer to packaging information.

Glossary

Item	Description
V_N	Nominal Varistor Voltage Voltage, at specified D.C. current used as a reference point in the component characteristics.
I_L	Leakage Current Measuring at 75% of varistor voltage.
UCT	Upper Category Temp. Max. ambient temp. for which a varistor has been designed to operate continuously.
LCT	Lower Category Temp. Minimum ambient temp. at which a varistor has been designed to operate continuously.
Max. Peak Current	Max. Peak Current Max. current per pulse, which may be passed by a varistor at an ambient temp. of 25 °C, for a given number of pulses.
V_C	Clamping Voltage Peak voltage developed across the varistor terminations under standard atmospheric conditions, when passing an 8/20 μ s class current pulse.
Voltage Proof	Voltage Proof Max. peak voltage, which may be applied under continuous operating conditions between the varistor terminations and any conducting mounting surface (Applicable only to insulated varistors).
C_V	Capacitance Capacitance across the MOV measured at a specified frequency and voltage.
V_{ac}	Max. Continuous a.c. Voltage Max. a.c. r.m.s. voltage of a substantially sinusoidal waveform (less than 5% total harmonic distortion) which can be applied to the component under continuous operating conditions at 25 °C.
V_{dc}	Max. Continuous d.c. Voltage Max. d.c. voltage (with less than 5% ripple) which can be applied to the component under continuous operating conditions at an ambient temp. of 25 °C.

MOV
Metal Oxide Varistor



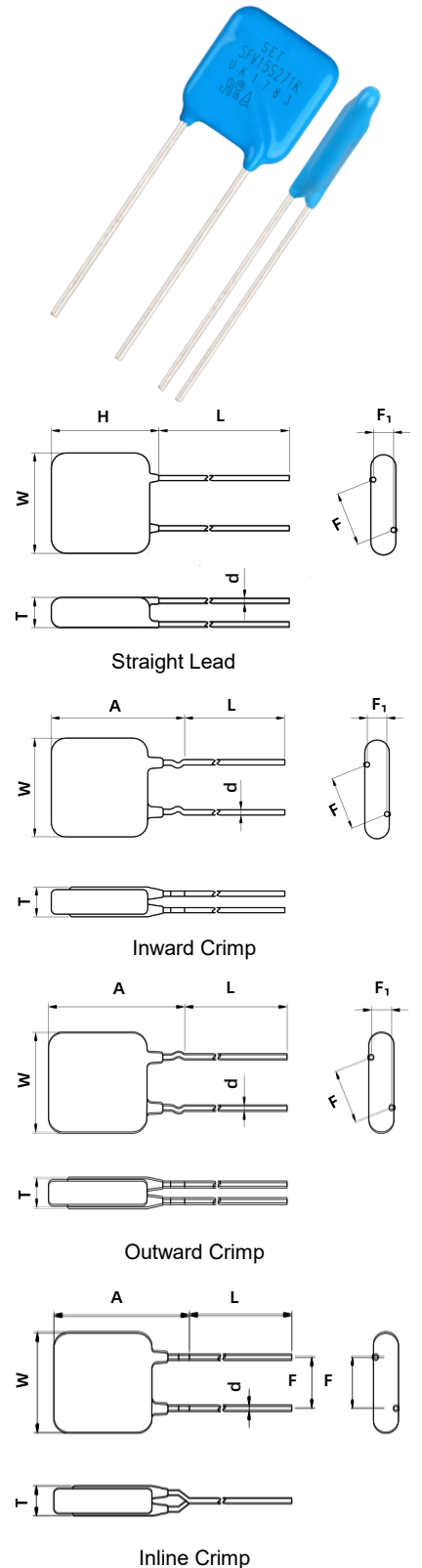

Dimensions (mm)

Model	L (Min.)	W (Max.)	H (Max.)	T (Max.)	d	F	F ₁	A (Max.)
SFV15S220K	20	17	20	4.9	1.00±0.0	10.0±0.6	1.2 - 2.7	22.5
SFV15S270K	20	17	20	5.2	1.00±0.0	10.0±0.6	1.3 - 2.9	22.5
SFV15S330K	20	17	20	5.5	1.00±0.0	10.0±0.6	1.4 - 3.1	22.5
SFV15S390K	20	17	20	5.8	1.00±0.0	10.0±0.6	1.5 - 3.3	22.5
SFV15S470K	20	17	20	5.0	1.00±0.0	10.0±0.6	1.3 - 2.9	22.5
SFV15S560K	20	17	20	5.2	1.00±0.0	10.0±0.6	1.4 - 3.1	22.5
SFV15S680K	20	17	20	5.5	1.00±0.0	10.0±0.6	1.5 - 3.4	22.5
SFV15S820K	20	17	20	4.8	1.00±0.0	10.0±0.6	1.3 - 2.8	22.5
SFV15S101K	20	17	20	5.0	1.00±0.0	10.0±0.6	1.4 - 3.0	22.5
SFV15S121K	20	17	20	5.2	1.00±0.0	10.0±0.6	1.5 - 3.2	22.5
SFV15S151K	20	17	20	5.5	1.00±0.0	10.0±0.6	1.6 - 3.5	22.5
SFV15S181K	20	17	20	4.9	1.00±0.0	10.0±0.6	1.4 - 3.0	22.5
SFV15S201K	20	17	20	5.0	1.00±0.0	10.0±0.6	1.5 - 3.1	22.5
SFV15S221K	20	17	20	5.1	1.00±0.0	10.0±0.6	1.6 - 3.3	22.5
SFV15S241K	20	17	20	5.2	1.00±0.0	10.0±0.6	1.7 - 3.4	22.5
SFV15S271K	20	17	20	5.4	1.00±0.0	10.0±0.6	1.8 - 3.5	22.5
SFV15S301K	20	17	20	5.6	1.00±0.0	10.0±0.6	1.9 - 3.7	22.5
SFV15S331K	20	17	20	5.8	1.00±0.0	10.0±0.6	2.0 - 3.9	22.5
SFV15S361K	20	17	20	6.0	1.00±0.0	10.0±0.6	2.1 - 4.1	22.5
SFV15S391K	20	17	20	6.1	1.00±0.0	10.0±0.6	2.2 - 4.2	22.5
SFV15S431K	20	17	20	6.4	1.00±0.0	10.0±0.6	2.5 - 4.5	22.5
SFV15S471K	20	17	20	6.6	1.00±0.0	10.0±0.6	2.7 - 4.7	22.5
SFV15S511K	20	17	20	6.8	1.00±0.0	10.0±0.6	2.9 - 4.9	22.5
SFV15S561K	20	17	20	7.1	1.00±0.0	10.0±0.6	3.2 - 5.2	22.5
SFV15S621K	20	17	20	7.5	1.00±0.0	10.0±0.6	3.5 - 5.5	22.5
SFV15S681K	20	17	20	7.8	1.00±0.0	10.0±0.6	3.9 - 5.9	22.5
SFV15S751K	20	17	20	8.3	1.00±0.0	10.0±0.6	4.3 - 6.3	22.5
SFV15S821K	20	17	20	8.7	1.00±0.0	10.0±0.6	4.7 - 6.7	22.5



Note:
The above data is for reference only.

Specification

Model	Max. Continuous Operating Voltage		Varistor Voltage @1 mA DC		Clamping Voltage (Max.)		Max. Discharge Current (8/20 μs)		Max. Energy (10/1000 μs)	Typical Capacitance (For reference only) @1 kHz	Agency Approvals			
	VAC	VDC	Min.	Max.	V _C	I _P	I _n	I _{max}	(J)	(pF)				
	(V)	(V)	(V)	(V)	(V)	(A)	(kA)	(kA)			UL	cUL	TUV	CQC
SFV15S220K	14	18	20	24	43	10	1.5	3	13	15000	●	●	●	○
SFV15S270K	17	22	24	31	53	15	1.5	3	16	10500	●	●	●	○
SFV15S330K	20	26	30	36	65	15	1.5	3	19	9300	●	●	●	○
SFV15S390K	25	31	35	43	77	15	1.5	3	21	7000	●	●	●	○
SFV15S470K	30	38	42	52	93	15	1.5	3	27	6000	●	●	●	○
SFV15S560K	35	45	50	62	110	15	1.5	3	32	5300	●	●	●	○
SFV15S680K	40	56	61	75	135	15	1.5	3	41	4700	●	●	●	○
SFV15S820K	50	65	74	90	135	75	5	10	43	4000	●	●	●	○
SFV15S101K	60	85	90	110	165	75	5	10	53	3200	●	●	●	○
SFV15S121K	75	100	108	132	200	75	5	10	64	2700	●	●	●	○
SFV15S151K	95	125	135	165	250	75	5	10	85	2200	●	●	●	○
SFV15S181K	115	150	162	198	300	75	5	10	96	1800	●	●	●	○
SFV15S201K	130	170	180	220	340	75	5	10	102	1600	●	●	●	○
SFV15S221K	140	180	198	242	360	75	5	10	125	1450	●	●	●	○
SFV15S241K	150	200	216	264	395	75	5	10	134	1350	●	●	●	○
SFV15S271K	175	225	243	297	455	75	5	10	158	1200	●	●	●	○
SFV15S301K	190	250	270	330	500	75	5	10	173	1050	●	●	●	○
SFV15S331K	210	275	297	363	550	75	5	10	185	1000	●	●	●	○
SFV15S361K	230	300	324	396	595	75	5	10	208	900	●	●	●	○
SFV15S391K	250	320	351	429	650	75	5	10	224	800	●	●	●	○
SFV15S431K	275	350	387	473	710	75	5	10	248	750	●	●	●	○
SFV15S471K	300	385	423	517	775	75	5	10	280	680	●	●	●	○
SFV15S511K	320	415	459	561	845	75	5	10	300	630	●	●	●	○
SFV15S561K	350	460	504	616	925	75	5	10	310	580	●	●	●	○
SFV15S621K	385	505	558	682	1025	75	5	10	310	530	●	●	●	○
SFV15S681K	420	560	612	748	1120	75	5	10	320	500	●	●	●	○
SFV15S751K	460	615	675	825	1240	75	5	10	335	430	●	●	●	○
SFV15S821K	510	670	738	902	1355	75	5	10	350	400	●	●	●	○

● : Approved ○ : No application for certification

MOV

MOV

Performance Curve (For reference only)

- Max. Peak Current Derating Curves

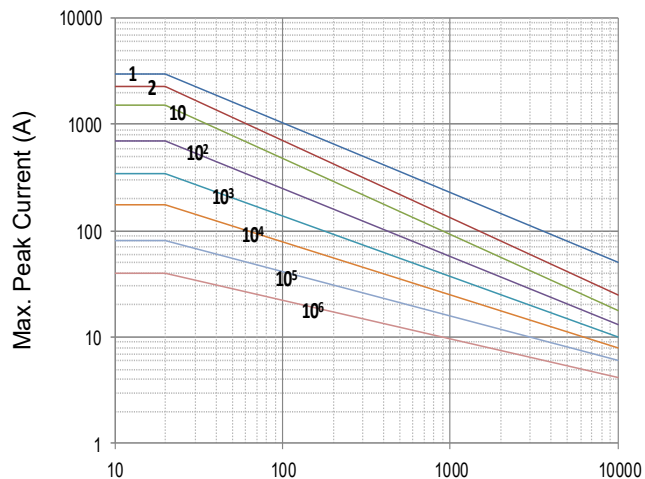

Impulse Duration (µs)

SFV15S220K to SFV15S680K

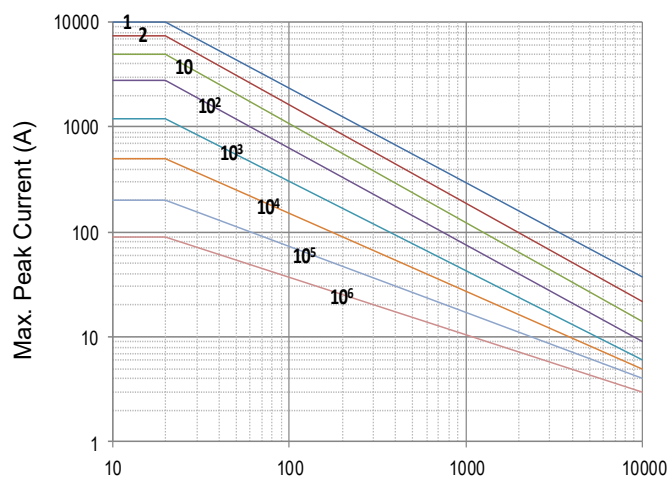

Impulse Duration (µs)

SFV15S820K to SFV15S821K

Note: 1, 2, 10, 10², 10³, 10⁴, 10⁵, 10⁶ Stand for Repetitions.

- Voltage-Current Characteristic Curves

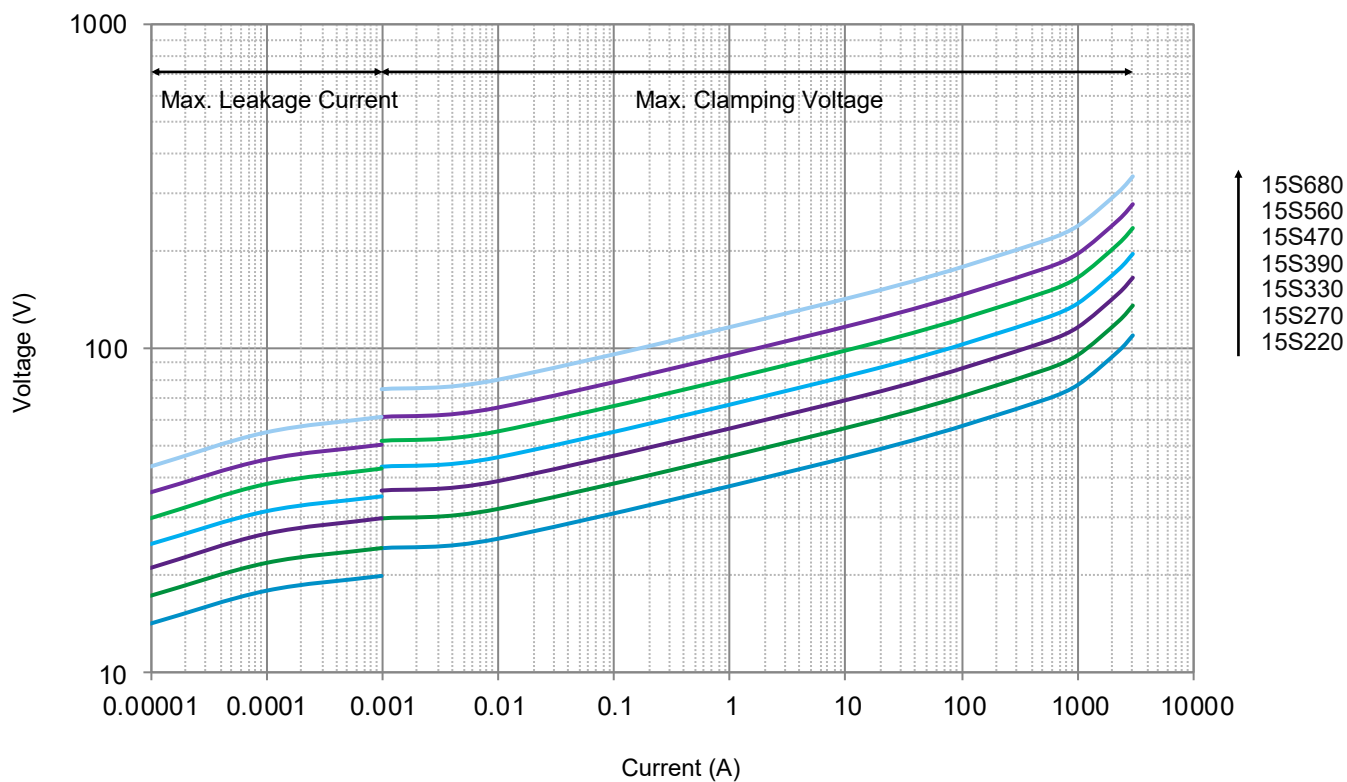

• Voltage-Current Characteristic Curves

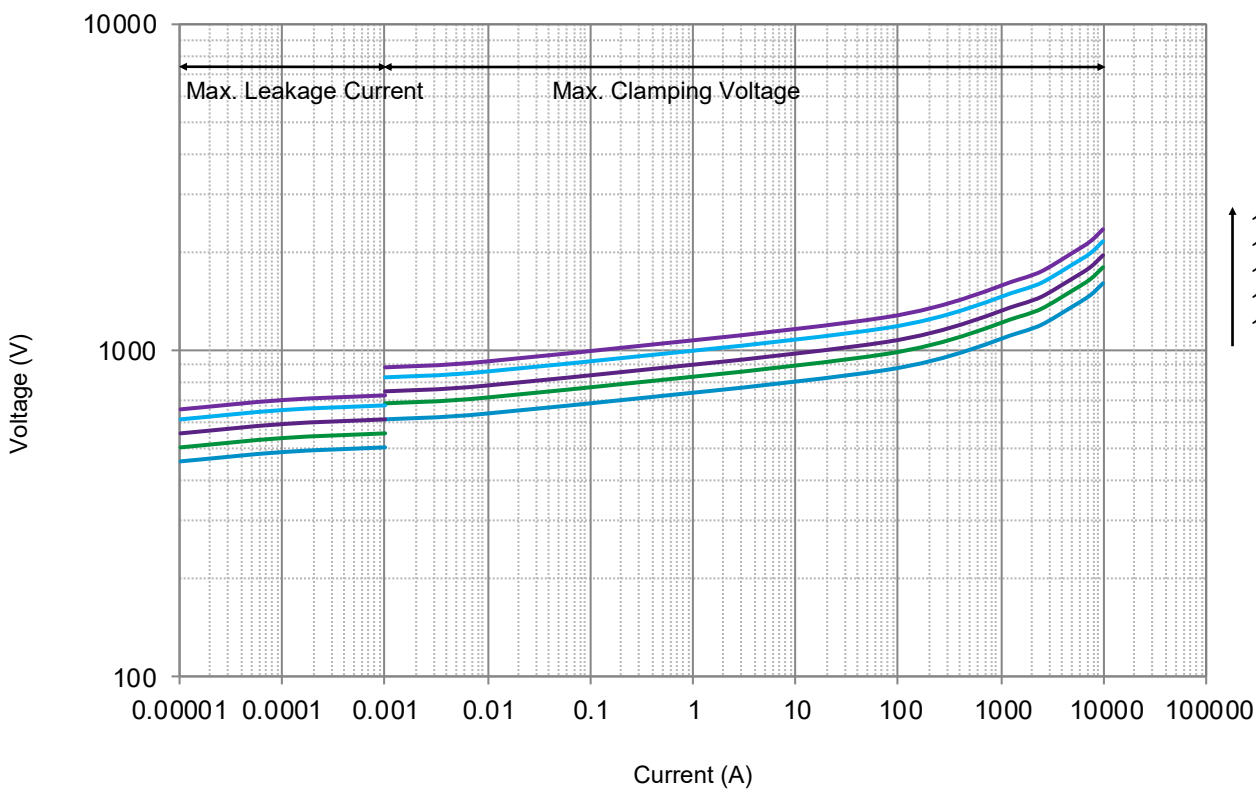
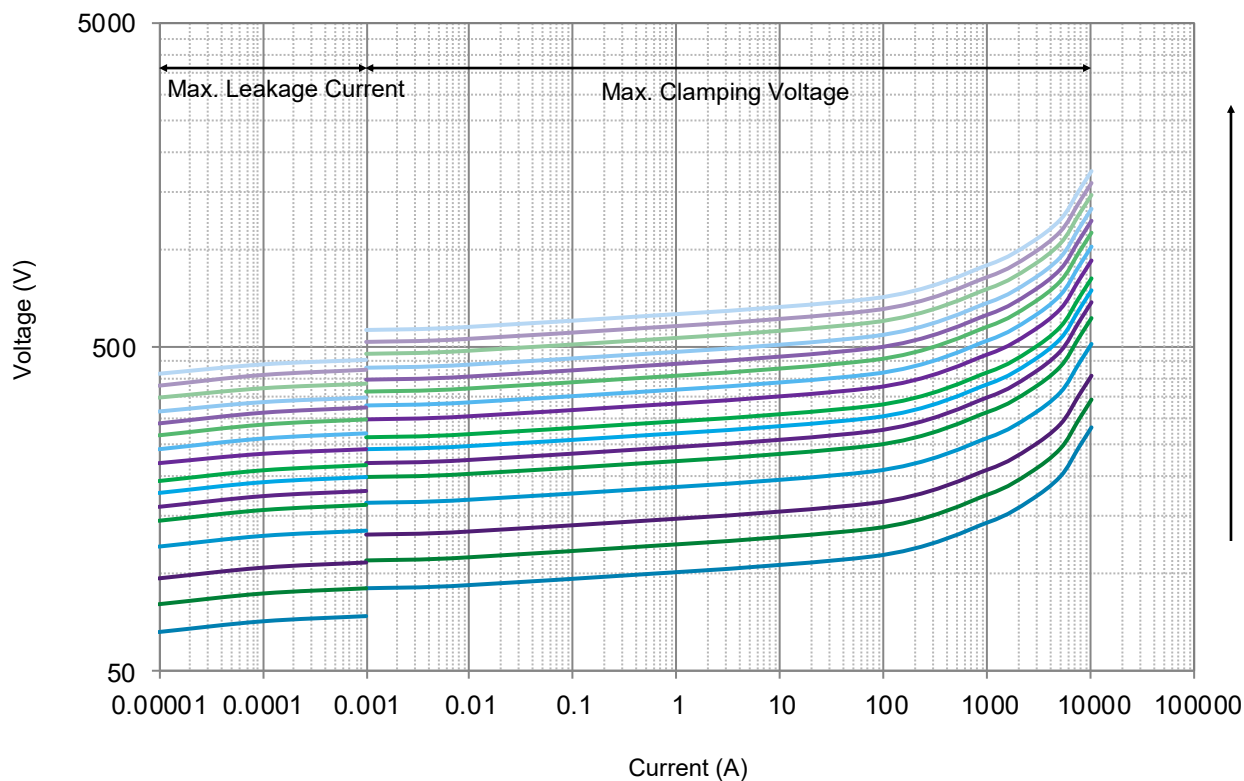

Soldering Parameters

Wave Soldering Parameters

The wave soldering parameters are for reference only. When MOV is for practice use, some related validation is recommended.

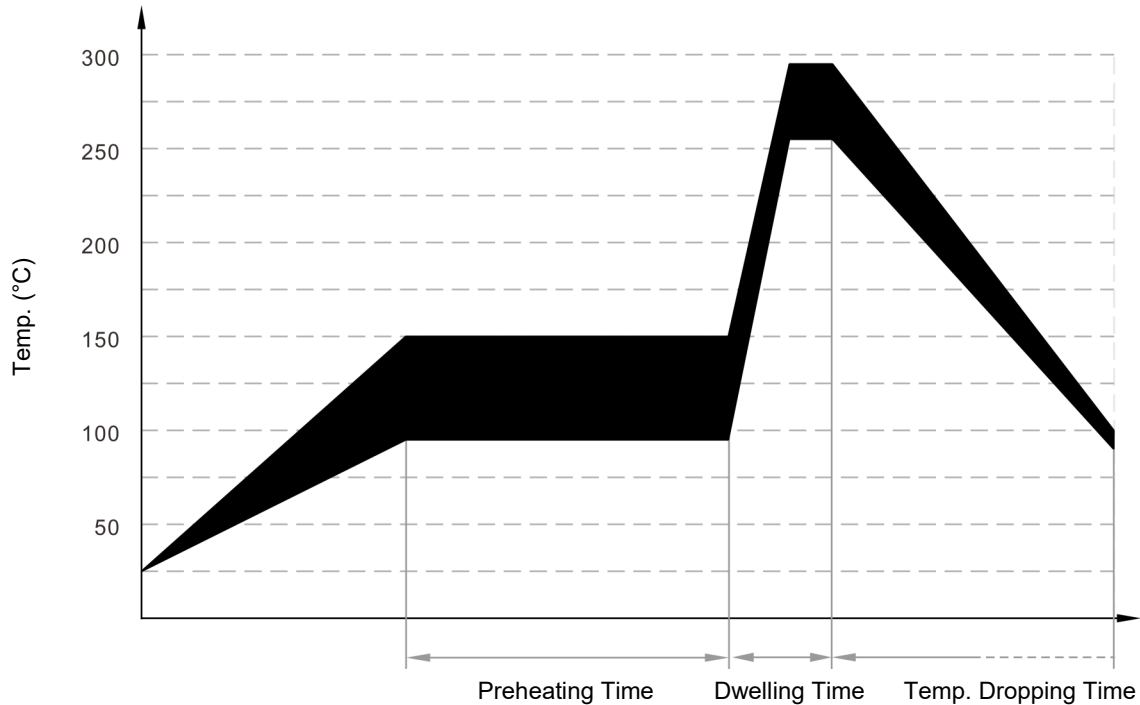

Wave Soldering Curve

Item	Temp. (°C)	Time (s)
Preheating	90 to 150	<150
Dwelling	255 to 290	3 to 10

Recommended Hand-Soldering Parameters

Item	Condition
Temp. of Solder Head	350 °C (max.)
Soldering Time	4 seconds (max.)

Packaging Information

- Bulk Packaging (Code: BUL)
- Bulk Packaging Quantity & Weight.

Series	Nominal Varistor Voltage	PE Bag	Box	Carton	G. W / Carton (365 × 265 × 245)
	(V)	(PCS)	(PCS)	(PCS)	(kg)±10%
15S	180 - 361	200	400	2400	4 - 7
	391 - 751	150	300	1800	5 - 8
	821	100	200	1200	9

Note:
Other lead length packaging information, please contact SETsafe | SETfuse.

All Dimensions in mm

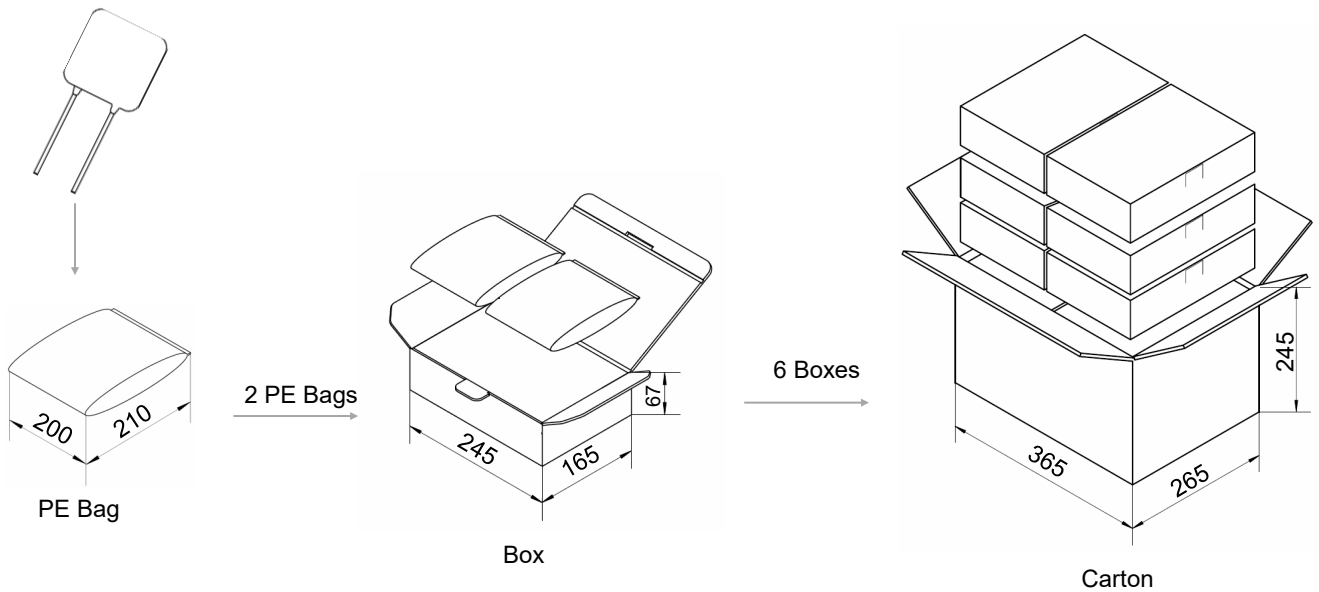



ATTENTION

MOV

MOV

Usage

1. Varistor must operated in the specified ambient temp.
2. Do not clean the varistor with strong polar solvent such as ketone, esters, benzene and halogenated hydrocarbon.
3. Please do not apply severe vibration, shock or pressure to MOV.
4. Please fix lead wires when bending or cutting. The distance between the bending point and the sealing of MOV shall be greater than 2 mm.

Replacement

If varistor is visually damaged, please replace it.

Storage

1. Storage Temp. Range: (-40 to +125) °C
2. Relative Humidity : ≤75% RH
3. Altitude: <2000 m
4. Do not store the MOV at the high temp., high humidity or corrosive gas environment, to avoid influencing the solder-ability of the lead wires, the product shall be used up within 1 year after receiving the goods.

Environmental Conditions

1. Varistor should neither be exposed to the open air, nor direct sunshine.
2. Varistor should avoid rain, water vapor or other condition of high temp. and high humidity.
3. Varistor should avoid sand dust, salt spray, or other harmful gases.

Max. Typical Capacitance of Varistor

The typical capacitance of varistor is listed in the specifications. Designers may refer to it when designing MOV in high frequency circuit.

Installation

Mechanical Stress

Do not knock MOV when installing, to avoid mechanical damage.