

# TRXF

Thermal-Link & Fusing Resistor

## TRXF2 Series (Axial Type)

### Without Tube

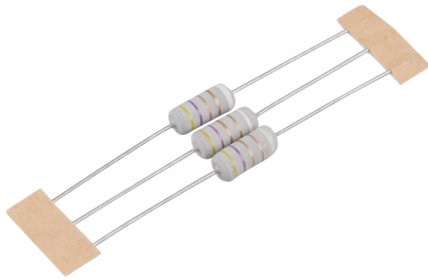

### With Tube



### Dimensions (mm)

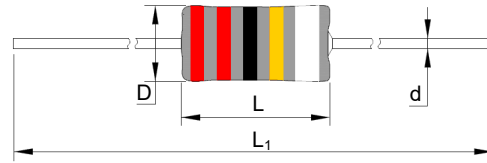

L	L <sub>1</sub> <sup>a</sup>	D	d
10.0 ± 1.0	60.0 ± 2.0 / 72.0 ± 2.0	Φ4.4 ± 0.5	Φ0.54 ± 0.05

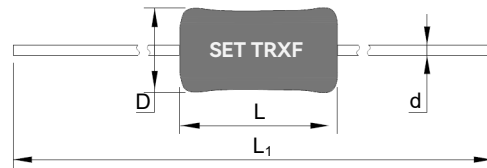

L	L <sub>1</sub> <sup>a</sup>	D	d
10.5 ± 1.0	60.0 ± 2.0 / 72.0 ± 2.0	Φ4.6 ± 0.5	Φ0.54 ± 0.05

Note:  
a: Blue font is SETsafe | SETfuse common length.

### Description

Thermal-Link & Fusing Resistor (TRXF) is a unique type of power resistor, with over temp. and over current protections. The Alloy Thermal-Link (ATCO) is placed through the core of Fusible Wirewound Resistor (RXF) and in series with RXF.

### Features

- Patented Product
- Over Temp. Protection
- Surge Protection
- Inrush Current Protection
- Small Fault Current Protection
- Short Circuit Protection
- RoHS & REACH Compliant



### Applications

- Switch Mode Power Supply (SMPS)
- Adapters
- LED Drivers
- Small Power Home Appliances

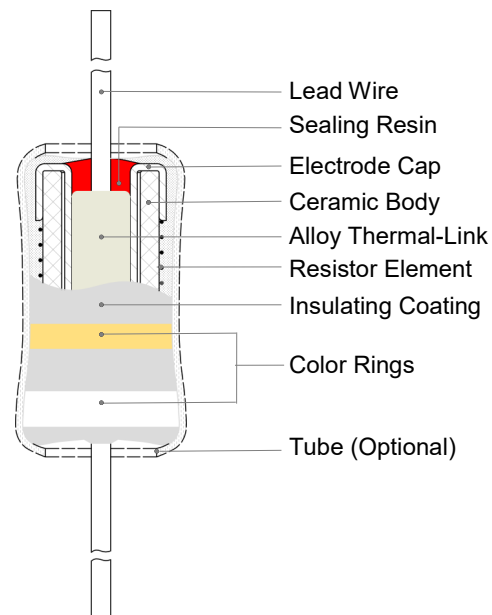
### Structure Diagram



### Agency Approvals

Agency	Standards	File No.	Resistance Range
 E324712	UL1412	E324712	0.27 Ω ~ 1,000 Ω
 TÜVRheinland	EN IEC 60127-8	R50560302	0.1 Ω ~ 1,000 Ω
 CQC	SJ 2865	CQC18001205501	0.47 Ω ~ 1,000 Ω

TRXF

TRXF

# TRXF

Thermal-Link & Fusing Resistor

## TRXF2 Series (Axial Type)

### Technical Parameter

Items	Parameters
Power Type ( <i>P</i> )	1 W
Rated Resistance ( <i>R</i> )	0.27 Ω ~ 1,000 Ω
Resistance Tolerance	5% ( E24 ), 10% ( E12 )
Derating Factor ( <i>f</i> )	See Rated Power Derating Curve
Actual Power ( <i>P<sub>0</sub></i> )	$P_0 = P \times f$
Rated Current ( <i>I<sub>N</sub></i> )	$I_N = \sqrt{P_0 / R}$
Rated Voltage ( <i>U<sub>N</sub></i> )	$U_N = \sqrt{P_0 \times R}$
Fusing Time	4 × <i>P<sub>0</sub></i> , less than 60 seconds
Fusing Temp.	216 °C ~ 221 °C
Surge	2.0 kV ( <i>R</i> > 10 Ω ) 1.0 kV ( <i>R</i> ≤ 10 Ω )

### Part Numbering System

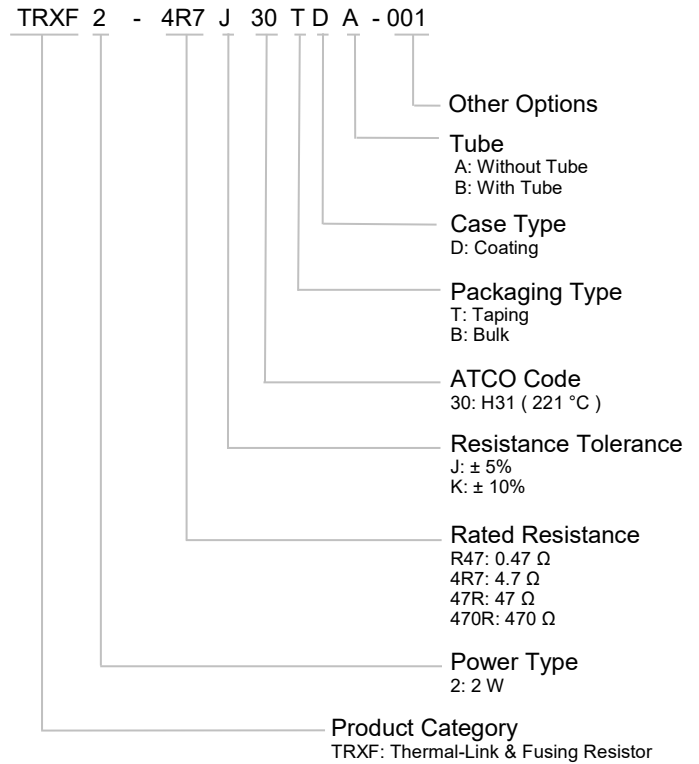

### Rated Power Derating Curve (For Reference Only)

When the ambient temp. exceeds 25 °C, the rated power value declines as the following curve.

(The Max. working temp. of heat shrinkable tube is 125 °C )

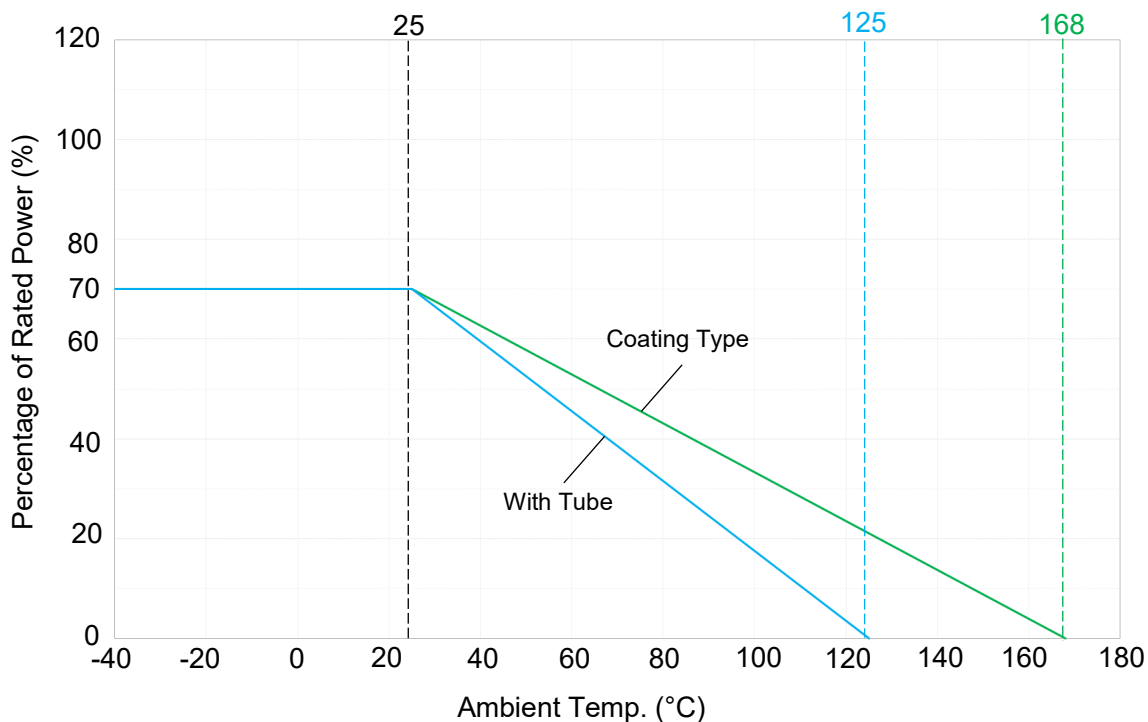



# TRXF

Thermal-Link & Fusing Resistor

## TRXF2 Series (Axial Type)

### Specifications

Series	Power Type	Derating Factor (25 °C)	Rated Resistance	Resistance Tolerance	Rated Functioning Temp. (T <sub>f</sub> )	Fusing Temp.	Agency Approvals			Environmental Status	
										RoHS	REACH
							UL	TUV	CQC		
TRXF2 (Axial Type)	2	70	0.27 ~ 0.43	± 5, ± 10	221	216 ~ 221	•	•	N/A	•	•
			0.47 ~ 1,000				•	•	•		

Resistance Selection Table (According to IEC60063-2015 E24, blue font is SETsafe | SETfuse common resistance).

Rated Resistance	Code	Rated Resistance	Code	Rated Resistance	Code	Rated Resistance	Code
(Ω)		(Ω)		(Ω)		(Ω)	
0.10	R10	1.0	1R0	10	10R	100	100R
0.11	R11	1.1	1R1	11	11R	110	110R
0.12	R12	1.2	1R2	12	12R	120	120R
0.13	R13	1.3	1R3	13	13R	130	130R
0.15	R15	1.5	1R5	15	15R	150	150R
0.16	R16	1.6	1R6	16	16R	160	160R
0.18	R18	1.8	1R8	18	18R	180	180R
0.20	R20	2.0	2R0	20	20R	200	200R
0.22	R22	2.2	2R2	22	22R	220	220R
0.24	R24	2.4	2R4	24	24R	240	240R
0.27	R27	2.7	2R7	27	27R	270	270R
0.30	R30	3.0	3R0	30	30R	300	300R
0.33	R33	3.3	3R3	33	33R	330	330R
0.36	R36	3.6	3R6	36	36R	360	360R
0.39	R39	3.9	3R9	39	39R	390	390R
0.43	R43	4.3	4R3	43	43R	430	430R
0.47	R47	4.7	4R7	47	47R	470	470R
0.51	R51	5.1	5R1	51	51R	510	510R
0.56	R56	5.6	5R6	56	56R	560	560R
0.62	R62	6.2	6R2	62	62R	620	620R
0.68	R68	6.8	6R8	68	68R	680	680R
0.75	R75	7.5	7R5	75	75R	750	750R
0.82	R82	8.2	8R2	82	82R	820	820R
0.91	R91	9.1	9R1	91	91R	910	910R

TRXF

TRXF

Glossary

Item	Description
RXF	<b>Fusible Wirewound Resistor</b> A power resistor which is made by winding a resistive element on a ceramic core, and the core is coated by insulation coating. It intends to interrupt a current flow at a predetermined time when the current exceeds the predetermined value, It is non-resettable.
ATCO	<b>Alloy Thermal-Link</b> Alloy Type Thermal-Link, alloy is the thermal element. Thermal-Link is a non-resettable device incorporating a THERMAL ELEMENT which will open a circuit once only when exposed for a sufficient length of time to a temp. in excess of that for which it has been designed.
R	<b>Rated Resistance</b> Resistance value for which the resistor has been designed, and which is generally used for denomination of the resistor.
$P_0$	The Max. power of TRXF can be used within the allowable operating temp. range.
TCR	<b>Temp. Coefficient of Resistance</b> Relative variation of resistance between two given temp. divided by the difference in the temp. producing it.
$I_N$	<b>Rated Current</b> $I_N = \sqrt{P_0 / R}$
$U_N$	<b>Rated Voltage</b> The d.c. or a.c. r.m.s. voltage calculated from the square root of the product of the rated resistance and the rated dissipation.
$T_f$	<b>Rated Functioning Temp.</b> The temp. of the ATCO which causes it to change the state of conductivity with a detection current up to 10 mA as the only load.
Fusing Temp.	<b>Fusing Temp.</b> The temp. of the TRXF which causes it to change its state of conductivity is measured with silicone oil bath in which the temp. is increased at the rate of 0.3 °C to 0.5 °C / min, with a detection current up to 10 mA as the only load.

Marking



Color	The First Number	The Second Number	Multiple	Resistance Tolerance	$T_f$
Black	0	0	$10^0$	—	—
Brown	1	1	$10^1$	—	—
Red	2	2	$10^2$	—	—
Orange	3	3	$10^3$	—	—
Yellow	4	4	$10^4$	—	—
Green	5	5	$10^5$	—	—
Blue	6	6	$10^6$	—	—
Purple	7	7	$10^7$	—	—
Grey	8	8	$10^8$	—	—
White	9	9	$10^9$	—	221 °C
Gold	—	—	$10^{-1}$	J: ± 5%	—
Silver	—	—	$10^{-2}$	K: ± 10%	—

## Operating Principle

### Instruction:

$$R_{RXF} \geq 100R_{ATCO}$$

- $R_{RXF}$ : The Resistance Value of RXF
- $R_{ATCO}$ : The Resistance Value of ATCO

$$T_{RXF} \geq 5T_{ATCO}$$

- The Fusing Temp. of RXF ( $T_{RXF}$ ): 1,200 °C ~ 1,500 °C
- The Fusing Temp. of ATCO ( $T_{ATCO}$ ): 221 °C

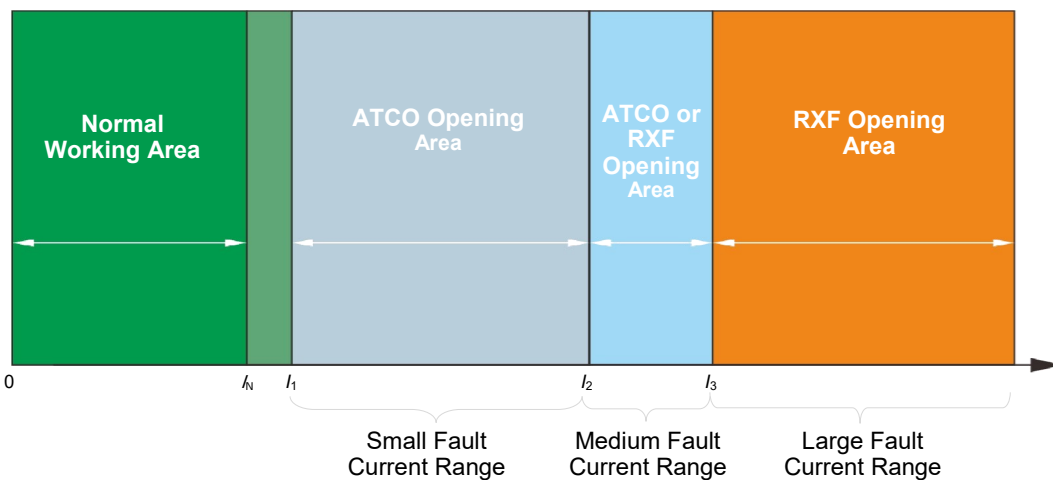
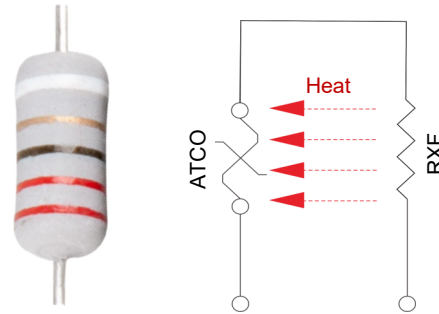

$I_N$ : Rated Current

$I_1$ : Conventional Fusing Current

### ● Small Fault Current Protection

At small fault current,  $I_1 < I < I_2$ , ATCO senses the heat that generated by RXF, when the ATCO reaches the fusing temp., ATCO opens the circuit quickly. In this case, RXF keeps intact and ATCO opens.

### ● Medium Fault Current Protection

At medium fault current,  $I_2 < I < I_3$ , RXF opens in a short time because of much heat generated, meanwhile, RXF conducts its residual heat to ATCO. In this case, both RXF and ATCO open.

### ● Large Fault Current Protection (Short Circuit Protection)

At large fault current, such as short circuit,  $I > I_3$ , RXF opens instantly but ATCO keeps intact because the fusing time of RXF is too short to generate enough heat. In this case, RXF opens and ATCO keeps intact.

### Fusing Time Curve (For Reference Only)

TRXF can open effectively at lower power multiples to protect the circuit timely (ambient temp. 25 °C ± 2 °C).

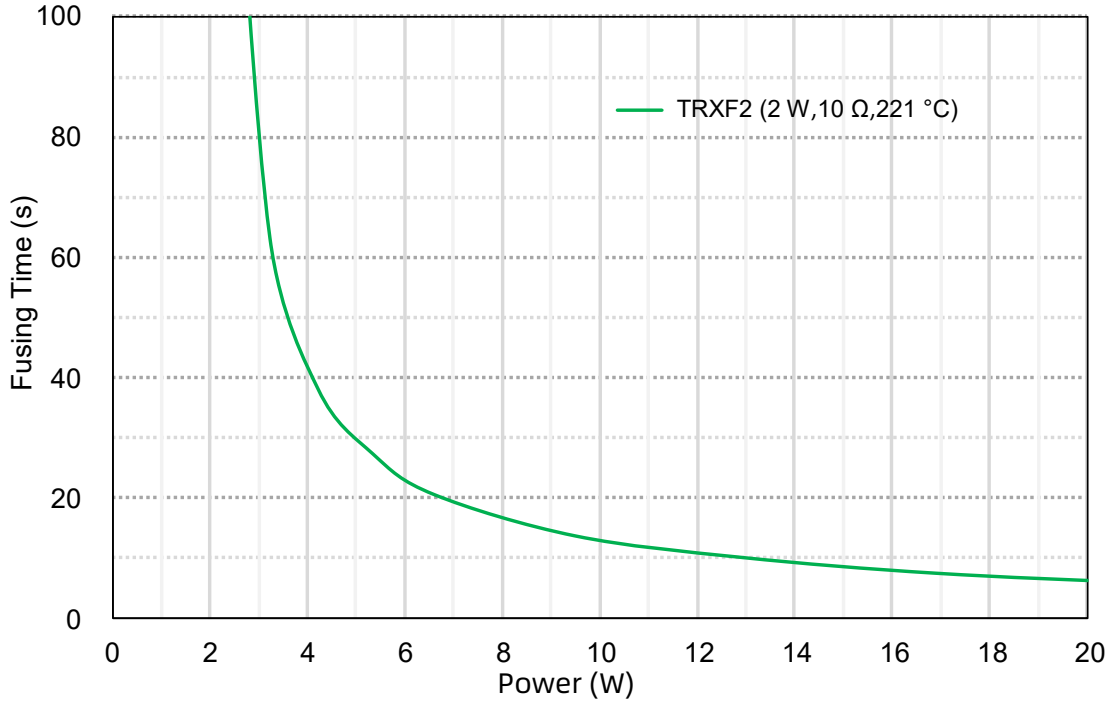

### Surface Temp. Curve (For Reference Only)

The surface temp. of TRXF is always at a lower level, when small fault current happens to the device, TRXF is able to open the circuit timely without additional damage (ambient temp. 25 °C ± 2 °C).

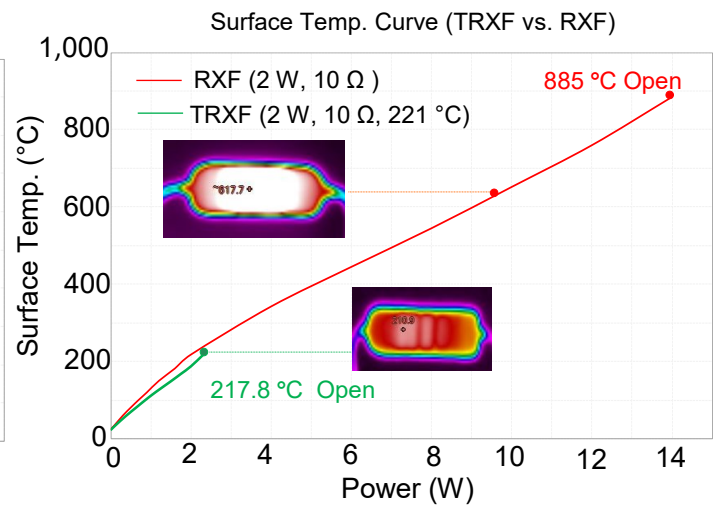
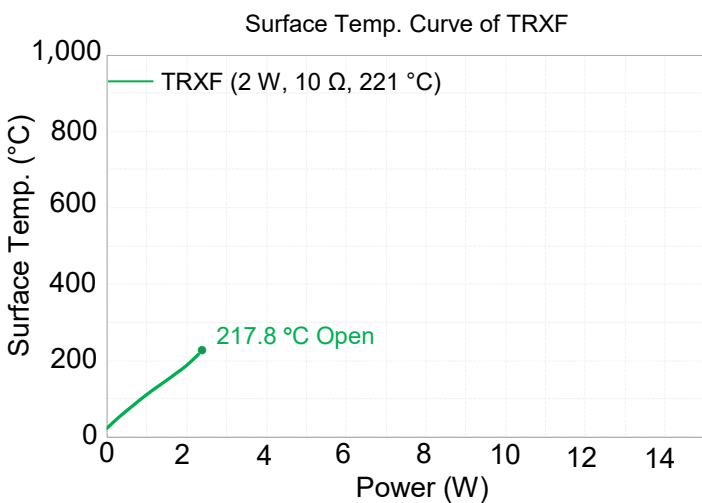

## Performance Test

### Mechanical Performance Test

Item	Test Condition	Criterion
Tensile Test	A lead withstand 10 N × 60 seconds	No Visible Damage $\Delta R \leq \pm (1\%R + 0.05 \Omega)$
Twist Test	A lead 2 mm away from body, bent 90°, twist 180° × 2 times	No Visible Damage $\Delta R \leq \pm (1\%R + 0.05 \Omega)$

### Environmental Test

Item	Test Condition	Criterion
Temp. Cycle	1. - 55 °C × 30 minutes 2. Room Temp. × (10 to 15) minutes 3. 85 °C × 30 minutes 4. Room Temp. × (10 to 15) minutes 5. 5 Cycles from Step 1 to Step 4	$\Delta R \leq \pm (2\%R + 0.05 \Omega)$

### Electrical Performance Test

Item	Test Condition	Criterion
TCR	$TCR = \frac{(R_2 - R_1)}{R_1 (T_2 - T_1)} \times 10^6$ R <sub>1</sub> : Resistance Value at 25 °C R <sub>2</sub> : Resistance Value at 125 °C	Within Specified Value
Short-Time Overload	2.5U <sub>N</sub> × 5 seconds	No Visible Damage
Insulation Resistance	Foil Method: Apply 500 VDC between both terminations of the TRXF connected together as one pole and the metal foil as the other pole.	Insulation Resistance ≥ 1,000 MΩ
Voltage Proof	Foil Method: Apply 350 VAC (Without Tube) or 900 VAC (With Tube) × 1 minute between terminations and the metal foil.	No Breakdown or Flashover
Fusing Test	Apply test current to the resistor (constant current source).	Fusing Time ≤ 60 seconds
Solderability	Solder Bath (non-activated flux), Soldering Powder: 25% Rosin Alcohol, Bath Temp.: (255 ± 5) °C, Depth of Immersion (from the seating plane or component body): (1.5 to 2.0) mm, Time of Immersion: (2.5 ± 0.5) seconds.	Soldering Area ≥ 95%
Surge Test	Combination Wave Generator (1.2/50 μs, 8/20 μs, 2 Ω), apply open-circuit voltage 1.0 kV (R ≤ 10 Ω) or 2.0 kV (R > 10 Ω) to the resistor, 10 pulses test at 1 minute Interval.	Resistor shall not open after the test
Fusing Temp.	Silicone oil bath: temp. rise rate is 0.3 °C/min to 0.5 °C/min, detection current ≤ 10 mA.	216 °C ~ 221 °C

### Recommended Hand-Soldering Parameters

Solder Iron Temp.: (350 ± 5) °C

Soldering Time: 3 seconds Max.

### Wave Soldering Parameters (For Reference Only)

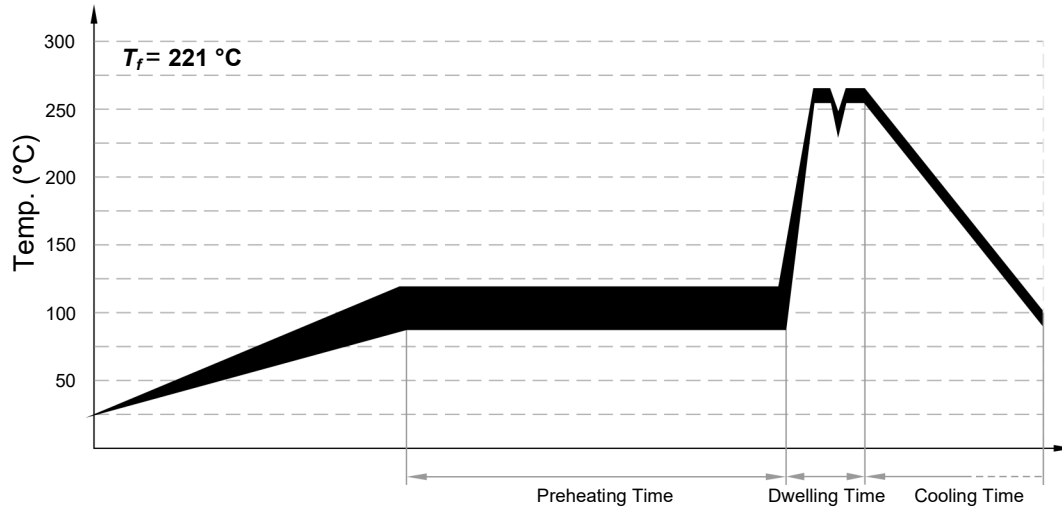

Item	Temp. (°C)	Time (second)
Preheating	90 ~ 120	60 ~ 100
Dwelling	260 ± 5	4 ~ 5

TRXF

TRXF



# TRXF

Thermal-Link & Fusing Resistor

## TRXF2 Series (Axial Type)

### Packaging Information

Taping

Total Length	Item	Box	Carton
60 mm	Quantity (PCS)	1,000	10,000
	Gross Weight (kg)	6.9 ± 10%	
72 mm	Quantity (PCS)	1,000	8,000
	Gross Weight (kg)	7.0 ± 10%	

Tape Dimensions (mm)		
Symbol	Total Length	
	60 mm	72 mm
W	52 ± 2	63 ± 2
L <sub>1</sub> (Without Tube)	10.0 ± 1.0	
L <sub>1</sub> (With Tube)	10.5 ± 1.0	
L <sub>2</sub> - L <sub>3</sub>	1.0 Max.	

Unit: mm

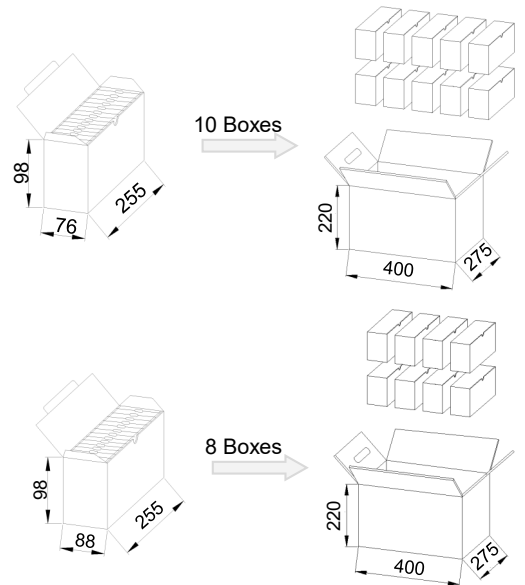
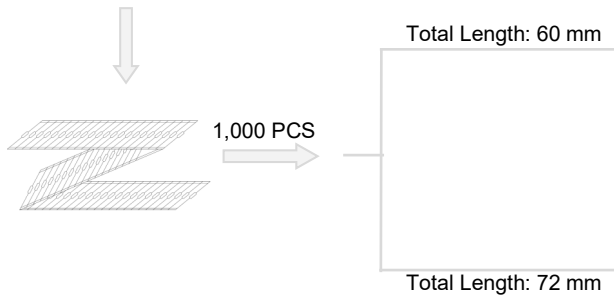
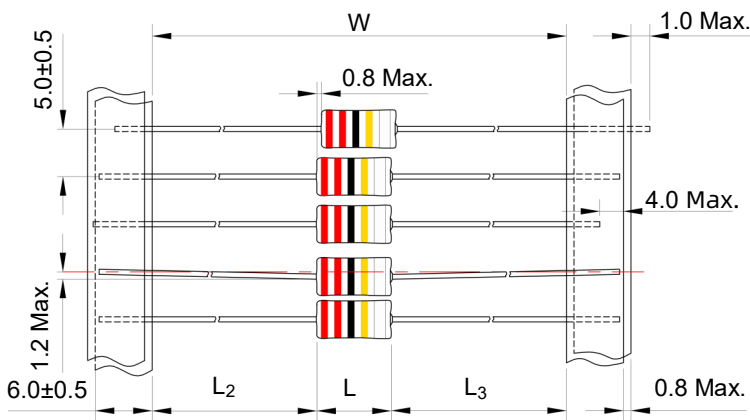

Bulk

Item	PE Bag	Tray	Carton
Quantity (PCS)	100	2,000	20,000
Gross Weight (kg)	12.5 ± 10%		

Unit: mm

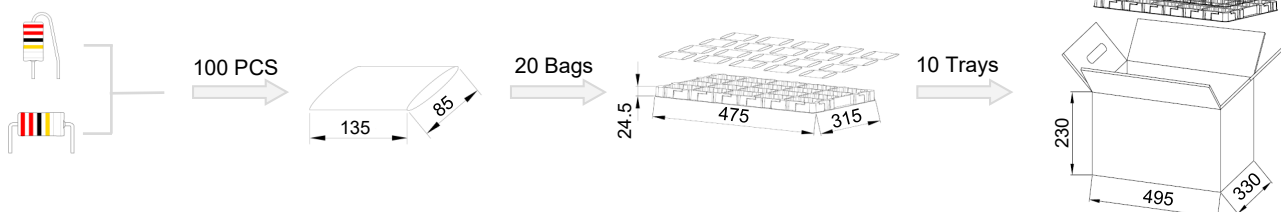



# ATTENTION

## Cold Resistance Test

1. If product TCR is not less than  $350 (10^{-6}/^{\circ}\text{C})$ , the measured resistance value shall be corrected as the relative resistance value under  $25^{\circ}\text{C}$  according to TCR formula.
2. Resistance Measurement (4-terminal test).

## Replacement

As TRXF is a non-resettable product, for safety sake, please use the same type of TRXF for replacement.

## Usage

1. Do not touch the resistor body or pins directly when power is on, to avoid burn or electric shock.
2. When air pressure is from 80 kPa to 106 kPa, the relative altitude shall be +2000 m to - 500 m.

## Storage

1. Please store TRXF with ambient temp.  $10^{\circ}\text{C} \sim 30^{\circ}\text{C}$  and relative humidity 30% ~ 75%.
2. Do not store the TRXF at the high temp., high humidity or corrosive gas environment, avoid influencing the solderability of the pins, please use them up within 1 year after receiving the goods.