

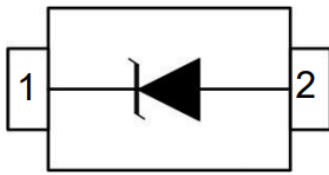

Pinout and Functional Block Diagram



Applications

- Microprocessor based equipment
- Personal Digital Assistants (PDA's)
- Notebooks, Desktops, and Servers
- Cell Phone Handsets and Accessories
- Portable Instrumentation
- Peripherals
- Pagers

Order Information

Type	Package	Marking Code	Delivery Form	Delivery Quantity
SDxxxxD52G1	SOD523	Refer to next page	7" T&R	3000 PCS

Limiting Values

(T_A = 25 °C, unless otherwise specified)

Symbol	Parameter	Conditions	Min	Max	Unit
V _{ESD}	Electrostatic Discharge Voltage	IEC 61000-4-2; Contact Discharge	-	30	kV
		IEC 61000-4-2; Air Discharge	-	30	kV
	ESD Voltage per human body model	JESD22-A114-B(ESD)		16	kV
	ESD Voltage per machine model			400	V
P _D	Total Power Dissipation on FR-5 Board	FR-5=1.0 x 0.75 x 0.62 in.@ Ta=25 °C	-	150	mW
T _A	Operating Temperature Range	-	-55	150	°C
T _{stg}	Storage Temperature Range	-	-55	150	°C

Description

The SDxxxxD52G1 series is designed to protect voltage sensitive components from ESD and transient voltage events. Excellent clamping capability, low leakage, and fast response time, make these parts ideal for ESD protection on designs where board space is at a premium. Because of its small size, it is suited for use in cellular phones, portable devices, digital cameras, power supplies and many other portable applications.

Features

- IEC61000-4-2 (ESD) ± 30 kV (Air), ± 30 kV (Contact)
- ESD Voltage Per Human Body Model : 16 kV
- ESD Voltage Per Machine Model : 400 V
- Protects One I/O Line (Unidirectional)
- Low Clamping Voltage
- Low Leakage Current
- High Temperature to Reflow Soldering Guaranteed: 260 °C / 10 sec
- Flammability Rating: UL 94 V-0
- Halogen Free and RoHS Compliant

ESD Protection Diodes

Unidirectional ESD and Transient Voltage Protection

SDxxxxD52G1 SOD523

Electrical Characteristics

(T_A = 25 °C, unless otherwise specified)

Part Number	Device Marking Code	V _{RWM}	I _R	V _B	I _T	V _C		V _C		P _{PK}	C _J
		(V)	(μA)	(V)	(mA)	(V)		(V)		(W)	(pF)
		Max	Max	Min		Max	@A	Max	@A	Max	Max
SD0209D52G1	ZD + code	2.5	6.0	4.0	1	9.0	5.0	11.5	9.0	104	145
SD0308D52G1	ZE + code	3.3	0.08	5.0	1	9.0	5.0	13.0	8.0	104	105
SD0316D52G1	ZE + code	3.3	0.08	5.0	1	9.0	5.0	13.0	16.0	208	105
SD0507D52G1	ZF + code	5.0	0.08	6.2	1	11.6	5.0	15.0	7.0	105	80
SD0606D52G1	ZG + code	6.0	0.05	6.8	1	13.5	5.0	17.5	6.0	105	70
SD0706D52G1	ZH + code	7.0	0.03	7.5	1	14.0	5.0	18.0	6.0	108	65
SD1204D52G1	ZM + code	12.0	0.03	14.1	1	20.0	1.0	26.0	4.0	104	45
SD1504D52G1	ZN + code	15.0	0.50	16.0	1	23.0	1.0	30.0	4.0	120	28

ESD TVS

ESD TVS

Performance Curve for Reference

($T_A=25^\circ\text{C}$ unless otherwise noted)

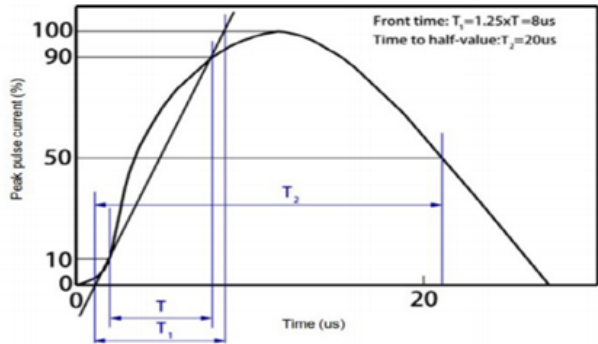

FIGURE 1

8 / 20 μs Waveform Per IEC61000-4-5

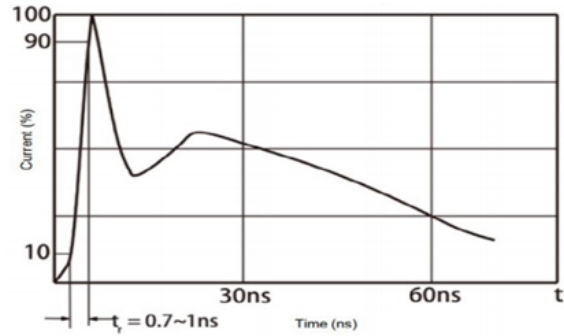

FIGURE 2

Contact Discharge Current Waveform Per IEC 61000-4-2

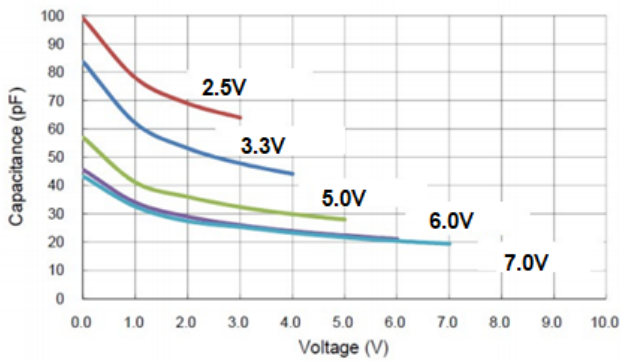

FIGURE 3

Voltage VS. Capacitance

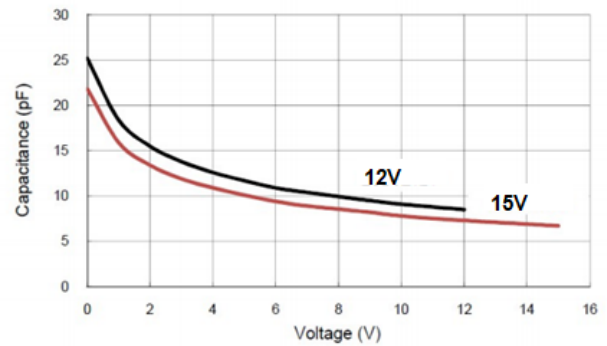

FIGURE 4

Voltage VS. Capacitance

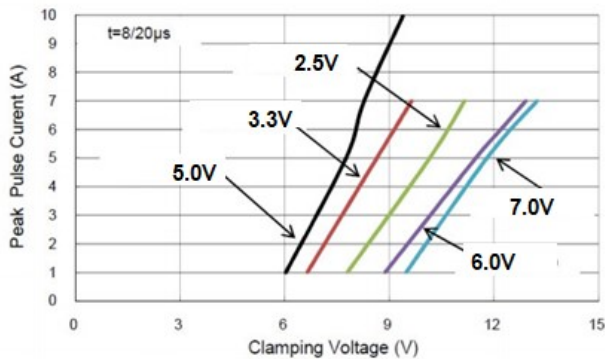

FIGURE 5

Clamping Voltage VS. Peak Pulse Current

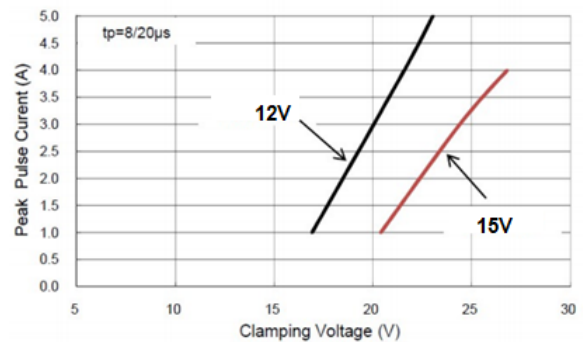

FIGURE 6

Clamping Voltage VS. Peak Pulse Current

ESD TVS

ESD TVS

ESD Protection Diodes

Unidirectional ESD and Transient Voltage Protection

SDxxxxD52G1 SOD523

Package Dimensions - SOD523

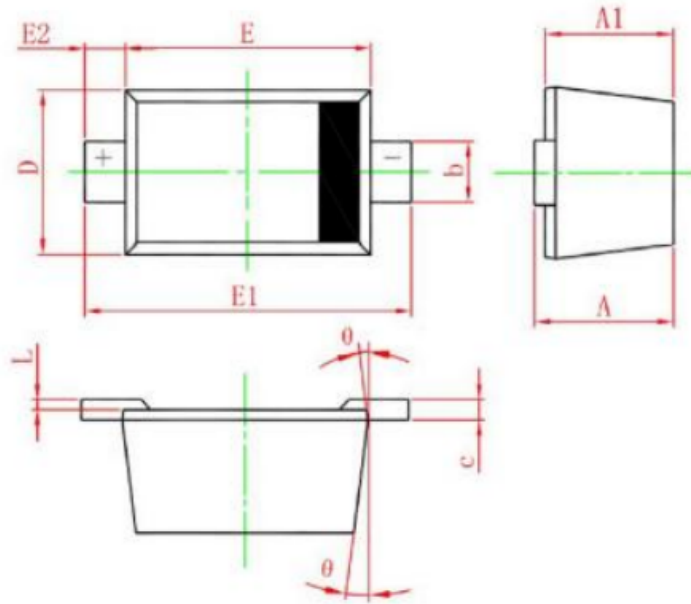

ESD TVS

ESD TVS

Symbol	Millimeters		Inches	
	Min.	Max.	Min.	Max.
A	0.51	0.77	0.020	0.031
A1	0.50	0.70	0.020	0.028
b	0.25	0.35	0.010	0.014
c	0.08	0.15	0.003	0.006
D	0.70	0.90	0.028	0.035
E	1.10	1.30	0.043	0.051
E1	1.50	1.70	0.059	0.067
E2	0.20 REF		0.008 REF	
L	0.01	0.07	0.001	0.003
φ	7 ° REF		7 ° REF	

Soldering Parameters

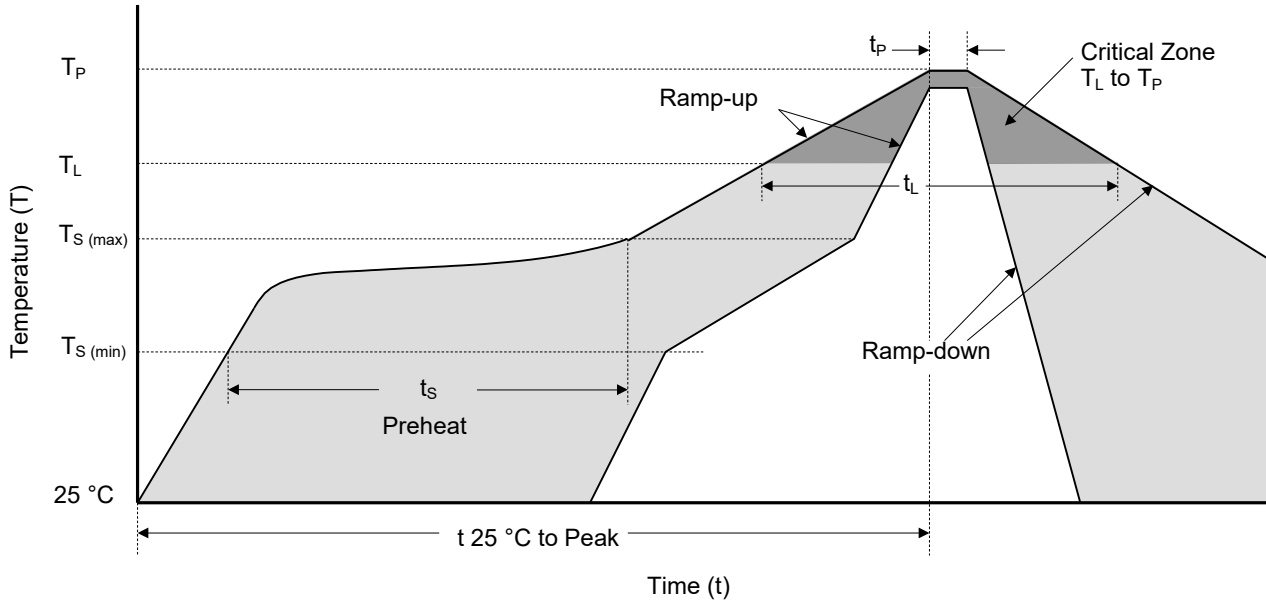

Reflowing Condition

Reflow Soldering Parameters		Lead-Free Assembly
Pre-heat	Temperature Min ($T_{S (min)}$)	150 °C
	Temperature Max ($T_{S (max)}$)	200 °C
	Time (min to max) (t_s)	60 ~ 120 seconds
Average Ramp Up Rate (Liquidus Temp (T_L) to Peak)		3 °C / second max.
$T_{S (max)}$ to T_L Ramp-up Rate		3 °C / second max.
Reflow	Temperature (T_L) (Liquidus)	217 °C
	Time (min to max) (t_L)	60 ~ 150 seconds
Peak Temperature (T_P)		260 ^{+0/-5} °C
Time of within 5 °C of Actual Peak Temperature (t_p)		20 ~ 40 seconds
Ramp-down Rate		6 °C / second max.
Time from 25 °C to Peak Temperature		8 Minutes max.
Do Not Exceed		260 °C



ATTENTION

Usage

1. TVS must be operated in the specified ambient temp.
2. Do not clean the TVS with strong polar solvent such as ketone, esters, benzene and halogenated hydrocarbon, to avoid damaging the encapsulating layer.
3. Please do not apply severe vibration, shock or pressure to TVS, to avoid element cracking.

Replacement

1. If TVS is visually damaged, please replace it.
2. TVS is a non-repairable product. For safety sake, please use equivalent TVS for replacement.

Storage

1. Storage Temp. Range: (-55 to 150) °C.
2. Do not store the TVS at the high temp., high humidity or corrosive gas environment, to avoid influencing the solder- ability of the lead wires. The product shall be used up within 1 year after receiving the goods.

Environmental Conditions

1. TVS should not be exposed to the open air, nor direct sunshine.
2. TVS should avoid rain, water vapor or other condition of high temp. and high humidity.
3. TVS should avoid sand dust, salt mist, or other harmful gases.

Max. Typical Capacitance of TVS

1. The typical capacitance of TVS is listed in the specifications. Designers may refer to it when designing TVS in High frequency circuit.

Installation Mechanical Stress

1. Do not knock TVS when installing, to avoid mechanical damage.
2. Please do not apply severe vibration, shock or pressure to TVS, to avoid surface resin or element cracking.