

# TVS Diodes

Transient Voltage Suppression Diodes

A5.0SMD Series



TVS

TVS

## Description

Transient Voltage Suppressor (TVS) is a circuit protection component that either attenuates (reduces) or filters a transient voltage spike (overvoltage), TVS diodes provide critical protection by going into avalanche breakdown within no more than a few nanoseconds after a strike, clamping the transient voltage, and routing its current to the ground.

## Applications

- Communication Equipment
- Security & Protection
- Industrial Control Equipment
- Power Supply
- Automotive Electronics
- New Energy
- Lightning Protection

## Functional Diagram

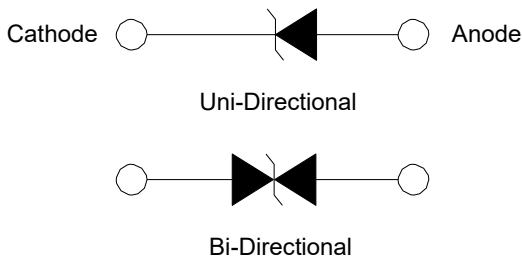

## Features

- Meet AEC-Q101 requirement
- Low incremental surge resistance
- Excellent clamping capability
- Low profile package with built-in strain relief
- Typical  $I_R$  less than 5.0  $\mu A$  above 22 V
- 5000 W peak pulse power capability with a 10/1000  $\mu S$  Waveform, repetition rate (duty cycle): 0.01%
- For surface mounted applications to optimize board space
- Typical failure mode is short from over-specified voltage or current
- IEC 61000-4-2 ESD 30 kV (Air), 30 kV (Contact)
- EFT protection of data lines in accordance with IEC 61000-4-4
- Very fast response time
- Glass passivated chip junction
- High temperature to reflow soldering guaranteed: 260  $^{\circ}C/40sec$
- $V_{BR} @ T_J = V_{BR@25^{\circ}C} \times (1 + \alpha T \times (T_J - 25))$   
( $\alpha T$ : Temperature Coefficient, typical value is 0.1%)
- Plastic package is flammability rated V-0 per Underwriters Laboratories
- Meet MSL level1, per J-STD-020
- Matte tin lead-free plated
- Halogen free and RoHS compliant
- Pb-free E3 means 2nd level interconnect is Pb-free and the terminal finish material is tin(Sn) (IPC/JEDEC J-STD-609A.01)

# TVS Diodes

Transient Voltage Suppression Diodes

A5.0SMD Series

## Package Outline Dimensions (DO-214AB)

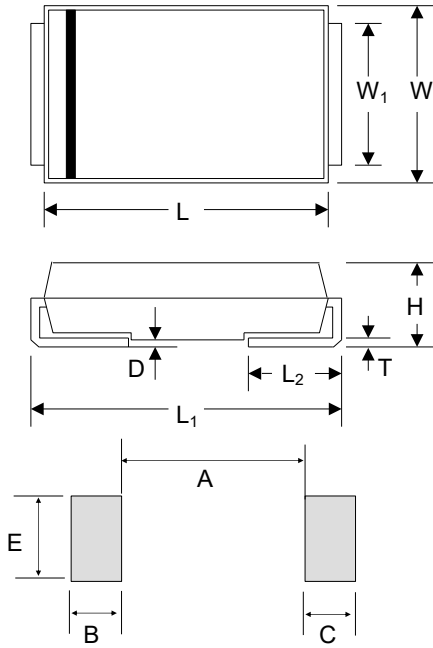

Mounting Pad Layout

Symbol	Millimeters		Inches	
	Min.	Max.	Min.	Max.
L	6.60	7.11	0.260	0.280
W	5.59	6.22	0.220	0.245
W <sub>1</sub>	2.90	3.20	0.114	0.126
H	2.06	2.62	0.079	0.103
T	0.152	0.305	0.006	0.012
L <sub>1</sub>	7.75	8.13	0.305	0.320
L <sub>2</sub>	0.76	1.52	0.030	0.060
D	-	0.203	-	0.008
A	-	4.20	-	0.165
B	2.40	-	0.094	-
C	2.40	-	0.094	-
E	3.30	-	0.129	-

TVS

TVS

## Maximum Ratings and Characteristics

(Ratings at 25 °C ambient temperature unless otherwise specified.)

Parameter	Symbol	Value	Unit
Peak Power Dissipation at $T_L=25\text{ °C}$ by 10/1000 $\mu\text{S}$ waveform <sup>(1)/(2)</sup> (Fig.2)	$P_{PPM}$	5000	W
Peak Power Dissipation on Infinite Heat Sink at $T_L=50\text{ °C}$	$P_D$	6.5	W
Peak Forward Surge Current, 8.3 ms single half sinewave superimposed on rated load (JEDEC Method) <sup>(3)</sup>	$I_{FSM}$	300	A
Maximum Instantaneous Forward Voltage at 100 A for Unidirectional Only	$V_F$	5.0	V
Operating Temperature Range	$T_J$	-65 to 150	°C
Storage Temperature Range	$T_{STG}$	-65 to 175	°C
Typical Thermal Resistance Junction to Lead	$R_{\theta JL}$	15	°C / W
Typical Thermal Resistance Junction to Ambient	$R_{\theta JA}$	75	°C / W

Notes

1. Non-repetitive current pulse, per Fig. 4 and derated above  $T_J(\text{initial})=25\text{ °C}$  per Fig. 3.
2. Mounted on 8.0 mm<sup>2</sup> land areas.
3. Measured of 8.3 ms single half sine-wave or equivalent square wave, duty cycle=4 pulses per minute maximum.

## Part Numbering System

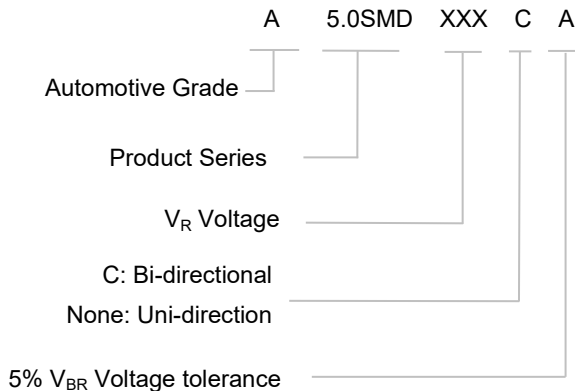

## Marking

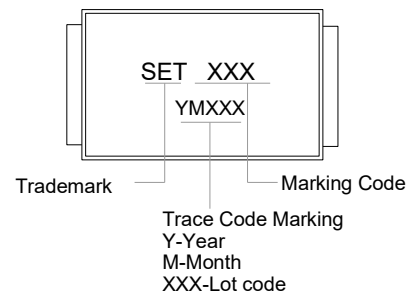
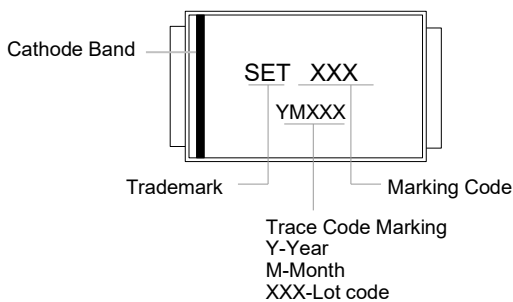

Glossary

Item	Description
$V_C$	<b>Clamping Voltage</b> Voltage across TVS in a region of low differential resistance that serves to limit the voltage across the device terminals.
$V_R$	<b>Reverse Stand-off Voltage</b> Maximum voltage that can be applied to the TVS without operation. NOTE : It is also shown as $V_{WM}$ (maximum working voltage (maximum d.c. voltage)) and known as rated stand-off voltage ( $V_{SO}$ ).
$I_R$	<b>Reverse Leakage Current</b> Current measured at $V_R$ . NOTE : Also shown as $I_D$ for stand-by current.
$V_{BR}$	<b>Breakdown Voltage</b> Voltage across TVS at a specified current $I_T$ in the breakdown region.
$I_{PPM}$	<b>Rated Random Recurring Peak Impulse Current</b> Maximum-rated value of random recurring peak impulse current that may be applied to a device.
$P_{M(AV)}$	<b>Rated Average Power Dissipation</b> Maximum-rated value of power dissipation resulting from all sources, including transients and standby current, averaged over a short period of time.
$P_{PPM}$	<b>Rated Random Recurring Peak Impulse Power Dissipation</b> Maximum-rated value of the product of rated random recurring peak impulse current ( $I_{PPM}$ ) multiplies by specified maximum clamping voltage ( $V_C$ ).
$C_J$	<b>Capacitance</b> Capacitance across the TVS measured at a specified frequency and voltage.
$V_{FS}$	<b>Peak Forward Surge Voltage</b> Peak voltage across an TVS for a specified forward surge current ( $I_{FS}$ ) and time duration. NOTE : Also shown as $V_F$ .
$I_{FS}$	<b>Forward Surge Current</b> Pulsed current through TVS in the forward conducting region. NOTE : Also shown as $I_F$ .
$\alpha_{V(BR)}$	<b>Temperature Coefficient of Breakdown Voltage</b> The change of breakdown voltage divided by the change of temperature.
$I_{PP}$	<b>Peak pulse Current</b> Peak pulse current value applied across the TVS to determine the clamping voltage $V_C$ for a specified wave shape.
$I_T$	<b>Pulsed D.C. Test Current</b> Test current for measurement of the breakdown voltage $V_{BR}$ . This is defined by the manufacturer and usually given in milliamperes with a pulse duration of less than 40 ms. NOTE : Also shown as $I_{BR}$ .

—(GB-T 18802.321 / IEC 61643-321 / JESD210A)

Electrical Characteristics (T<sub>A</sub>=25 °C unless otherwise noted )Table 1

Part Number		Device Marking Code		Breakdown Voltage V <sub>BR@I<sub>T</sub></sub>		Test Current I <sub>T</sub>	Reverse Stand-off Voltage V <sub>R</sub>	Max. Reverse Leakage I <sub>R@V<sub>R</sub></sub>	Max. Peak Pulse Current I <sub>PPM</sub> (10/1000 μS)	Max. Clamping Voltage V <sub>C@I<sub>PPM</sub></sub> (10/1000 μS)	Max. Peak Pulse Current I <sub>PPM</sub> (8/20 μS)	Max. Clamping Voltage V <sub>C@I<sub>PPM</sub></sub> (8/20 μS)
				Min	Max							
Uni	Bi	Uni	Bi	(V)		(mA)	(V)	(μA)	(A)	(V)	(A)	(V)
A5.0SMD12A	A5.0SMD12CA	APEP	ABEP	13.3	14.7	10	12	800	252	19.9	1890	25.7
A5.0SMD13A	A5.0SMD13CA	APEQ	ABEQ	14.4	15.9	10	13	500	233	21.5	1747.5	27.8
A5.0SMD14A	A5.0SMD14CA	APER	ABER	15.6	17.2	10	14	200	216	23.2	1620	30
A5.0SMD15A	A5.0SMD15CA	APES	ABES	16.7	18.5	1	15	100	205	24.4	1537.5	31.5
A5.0SMD16A	A5.0SMD16CA	APET	ABET	17.8	19.7	1	16	50	193	26	1447.5	33.6
A5.0SMD17A	A5.0SMD17CA	APEU	ABEU	18.9	20.9	1	17	20	181	27.6	1357.5	35.7
A5.0SMD18A	A5.0SMD18CA	APEV	ABEV	20	22.1	1	18	10	172	29.2	1290	37.7
A5.0SMD20A	A5.0SMD20CA	APEW	ABEW	22.2	24.5	1	20	5	155	32.4	850	41.9
A5.0SMD22A	A5.0SMD22CA	APEX	ABEX	24.4	26.9	1	22	5	141	35.5	1057.5	45.9
A5.0SMD24A	A5.0SMD24CA	APEZ	ABEZ	26.7	29.5	1	24	5	129	38.9	967.5	50.3
A5.0SMD26A	A5.0SMD26CA	APFE	ABFE	28.9	31.9	1	26	5	119	42.1	892.5	54.4
A5.0SMD28A	A5.0SMD28CA	APFG	ABFG	31.1	34.4	1	28	5	110	45.4	825	58.7
A5.0SMD30A	A5.0SMD30CA	APFK	ABFK	33.3	36.8	1	30	5	103	48.4	772.5	62.5
A5.0SMD33A	A5.0SMD33CA	APFM	ABFM	36.7	40.6	1	33	5	93.9	53.3	704.3	68.9
A5.0SMD36A	A5.0SMD36CA	APFP	ABFP	40	44.2	1	36	5	86.1	58.1	645.8	75.1
A5.0SMD40A	A5.0SMD40CA	APFR	ABFR	44.4	49.1	1	40	5	77.6	64.5	582	83.3
A5.0SMD43A	A5.0SMD43CA	APFT	ABFT	47.8	52.8	1	43	5	72.1	69.4	540.8	89.7
A5.0SMD45A	A5.0SMD45CA	APFV	ABFV	50	55.3	1	45	5	68.8	72.7	516	93.9

TVS

TVS

Electrical Characteristics (T<sub>A</sub>=25 °C unless otherwise noted )Table 1

Model		Device Marking Code		Breakdown Voltage V <sub>BR</sub> @I <sub>T</sub>		Test Current I <sub>T</sub>	Reverse Stand-off Voltage V <sub>R</sub>	Max. Reverse Leakage I <sub>R</sub> @V <sub>R</sub>	Max. Peak Pulse Current I <sub>PPM</sub> (10/1000 μS)	Max. Clamping Voltage V <sub>C</sub> @I <sub>PPM</sub> (10/1000μS)	Max. Peak Pulse Current I <sub>PPM</sub> (8/20 μS)	Max. Clamping Voltage V <sub>C</sub> @I <sub>PPM</sub> (8/20 μS)
				Min	Max							
Uni	Bi	Uni	Bi	(V)		(mA)	(V)	(μA)	(A)	(V)	(A)	(V)
A5.0SMD48A	A5.0SMD48CA	APFX	ABFX	53.3	58.9	1	48	5	64.7	77.4	485.3	100.0
A5.0SMD51A	A5.0SMD51CA	APFZ	ABFZ	56.7	62.7	1	51	5	60.7	82.4	455.3	106.5
A5.0SMD54A	A5.0SMD54CA	APGE	ABGE	60.0	66.3	1	54	5	57.5	87.1	431.3	112.5
A5.0SMD58A	A5.0SMD58CA	APGG	ABGG	64.4	71.2	1	58	5	53.5	93.6	401.3	120.9
A5.0SMD60A	A5.0SMD60CA	APGK	ABGK	66.7	73.7	1	60	5	51.7	96.8	387.8	125.1
A5.0SMD64A	A5.0SMD64CA	APGM	ABGM	71.1	78.6	1	64	5	48.6	103.0	364.5	133.1
A5.0SMD70A	A5.0SMD70CA	APGP	ABGB	77.8	86.0	1	70	5	44.3	113.0	332.3	146.0
A5.0SMD75A	A5.0SMD75CA	APGR	ABGR	83.3	92.1	1	75	5	41.4	121.0	310.5	156.3
A5.0SMD78A	A5.0SMD78CA	APGT	ABGT	86.7	95.8	1	78	5	39.7	126.0	297.8	162.8
A5.0SMD85A	A5.0SMD85CA	APGV	ABGV	94.4	104.0	1	85	5	36.5	137.0	273.8	177.0
A5.0SMD90A	A5.0SMD90CA	APGX	ABGX	100.0	111.0	1	90	5	34.3	146.0	257.3	188.6
A5.0SMD100A	A5.0SMD100CA	APGZ	ABGZ	111.0	123.0	1	100	5	30.9	162.0	231.8	209.3
A5.0SMD110A	A5.0SMD110CA	APHE	ABHE	122.0	135.0	1	110	5	28.3	177.0	212.3	228.7
A5.0SMD120A	A5.0SMD120CA	APHG	ABHG	133.0	147.0	1	120	5	26.0	193.0	195.0	249.4
A5.0SMD130A	A5.0SMD130CA	APHK	ABHK	144.0	159.0	1	130	5	24.0	209.0	180.0	270.0
A5.0SMD140A	A5.0SMD140CA	APHL	ABHL	156.0	172.0	1	140	5	22.2	226.1.0	166.5	292.1
A5.0SMD150A	A5.0SMD150CA	APHM	ABHM	167.0	185.0	1	150	5	20.6	243.0	154.5	314.0
A5.0SMD160A	A5.0SMD160CA	APHP	ABHB	178.0	197.0	1	160	5	19.3	259.0	144.8	334.6
A5.0SMD170A	A5.0SMD170CA	APHR	ABHR	189.0	209.0	1	170	5	18.2	275.0	136.5	355.3

Notes:

1. For bidirectional type having V<sub>R</sub> of 20 volts and less, the I<sub>R</sub> should be doubled.
2. For parts without A in the PN , the V<sub>BR</sub> tolerance is ± 10% and V<sub>C</sub> is 5% higher than parts with A .The parts without A are currently available, but not recommended for new designs. The parts with A are preferred.

I-V Curve Characteristics

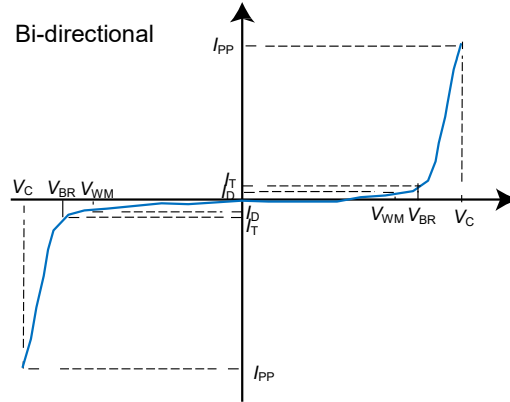
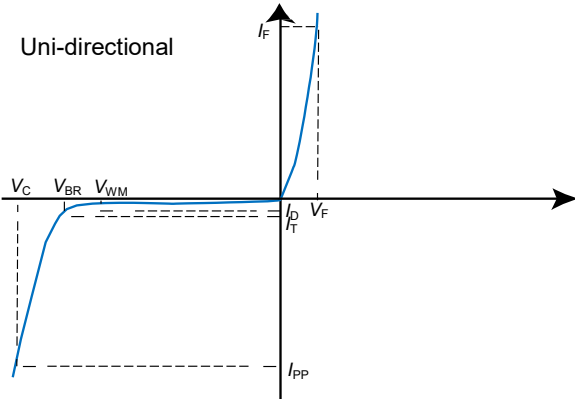

TVS

TVS

Performance Curve for Reference ( $T_A=25^\circ\text{C}$  unless otherwise noted)

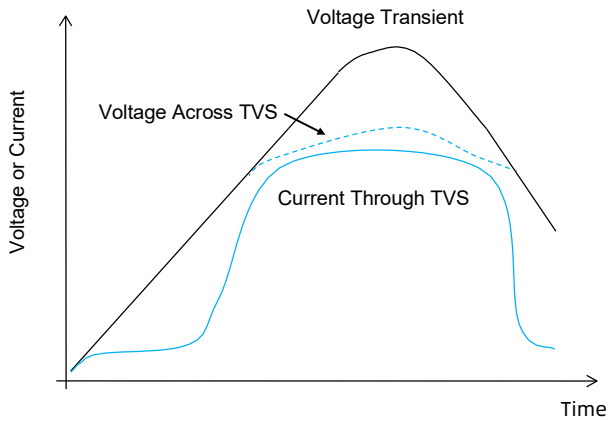

FIGURE 1 TVS Transients Clamping Waveform

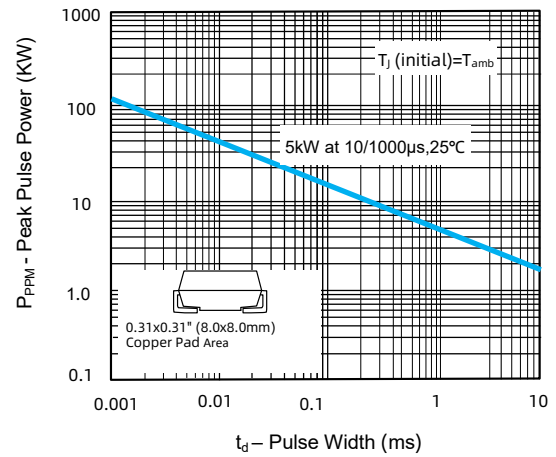

FIGURE 2 Peak Pulse Power Rating Curve

# TVS Diodes

Transient Voltage Suppression Diodes

A5.0SMD Series

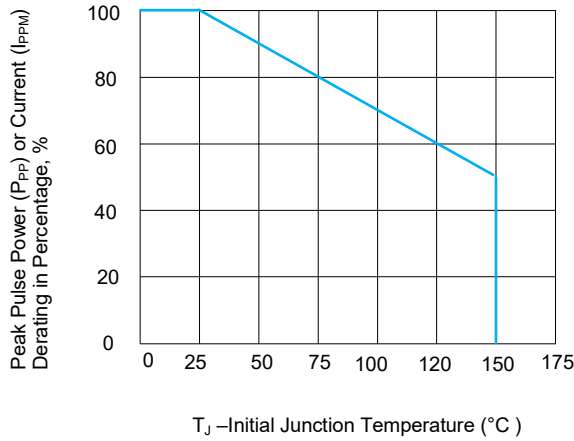

FIGURE 3 Peak Pulse Power Derating Curve

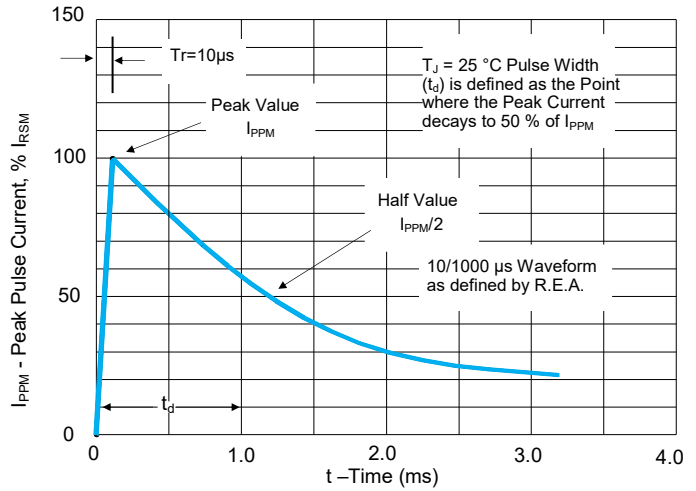

FIGURE 4 Pulse Waveform

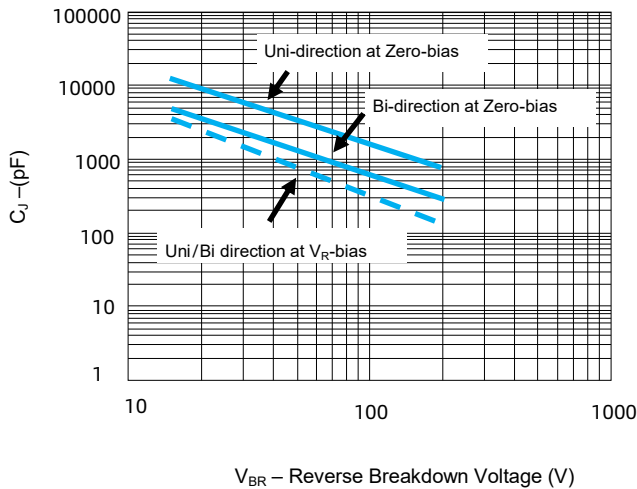

FIGURE 5 Typical Junction Capacitance

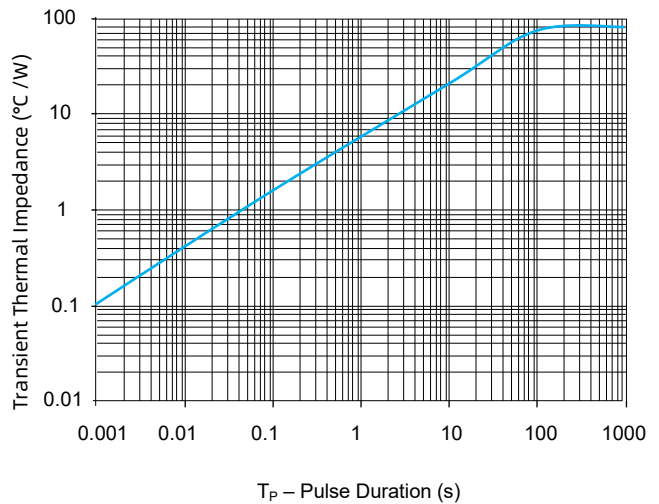

FIGURE 6 Typical Transient Thermal Impedance

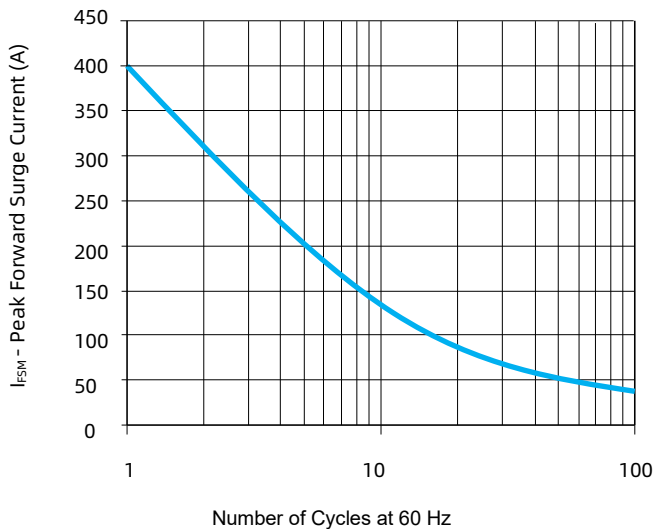

FIGURE 7 Maximum Non-Repetitive Forward Surge Current Uni-Directional only

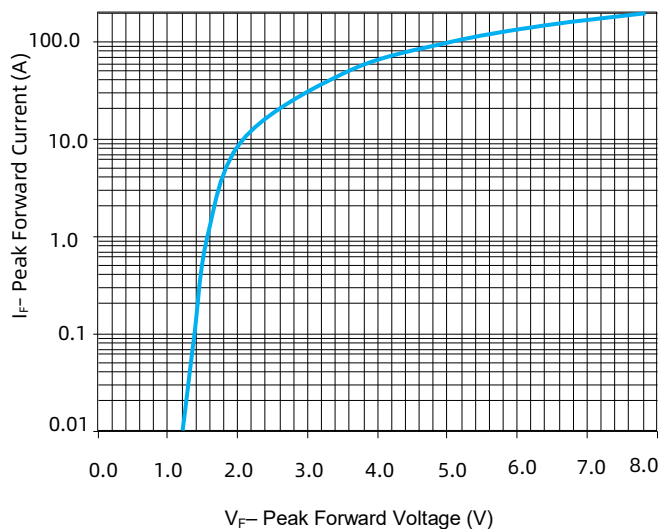

FIGURE 8 Peak Forward Drop vs Peak Forward Current (Typical Values)

TVS

TVS



Environmental Specifications

High Temp. Storage	JESD22-A103
HTRB	JESD22-A108
Temperature Cycling	JESD22-A104
MSL	JESDEC-J-STD-020, Level 1
H3TRB	JESD22-A101
RSH	JESD22-A111

Physical Specifications

Weight	0.007 ounce, 0.21 grams
Case	JESD22DO214AB. Molded plastic body over glass passivated junction
Polarity	Color band denotes positive end (cathode) except Bidirectional
Terminal	Matte Tin-plated leads, Solderability per JESD22-B102

Soldering Parameters

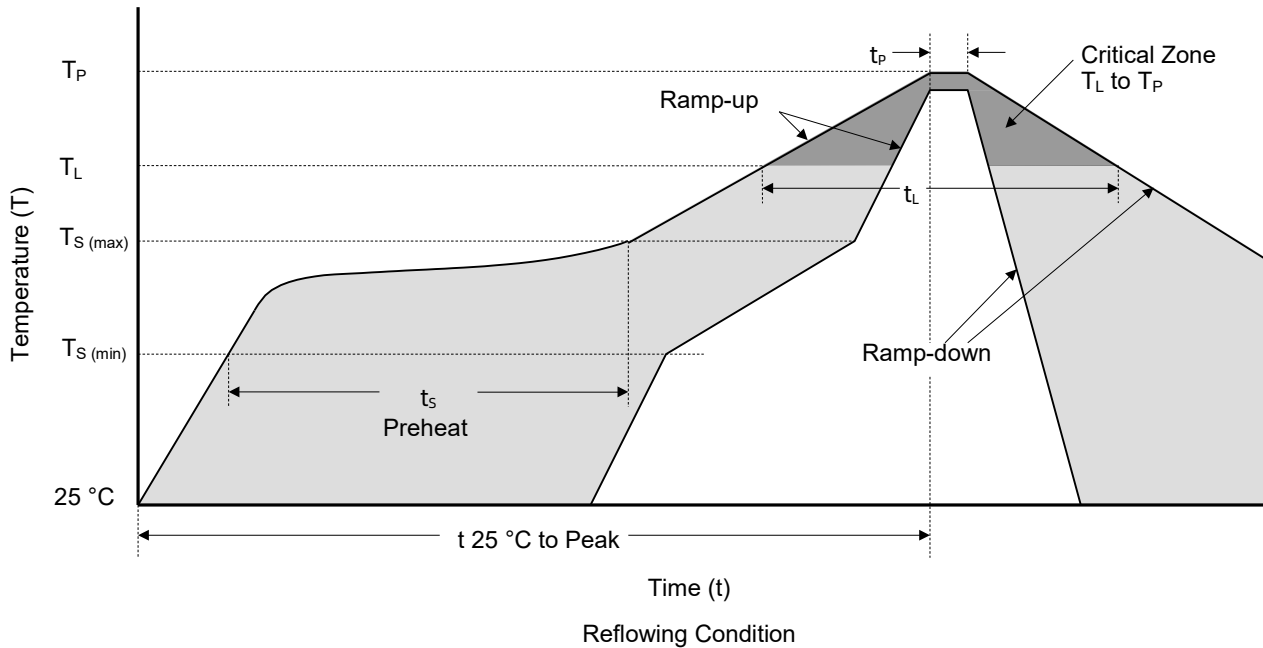

Reflow Soldering Parameters		Lead-Free Assembly
Pre-heat	Temperature Min ( $T_{S (min)}$ )	150 °C
	Temperature Max ( $T_{S (max)}$ )	200 °C
	Time (min to max) ( $t_s$ )	60 ~ 120 seconds
Average Ramp Up Rate (Liquidus Temp ( $T_L$ ) to Peak)		3 °C / second max.
$T_{S (max)}$ to $T_L$ Ramp-up Rate		3 °C / second max.
Reflow	Temperature ( $T_L$ ) (Liquidus)	217 °C
	Time (min to max) ( $t_L$ )	60 ~ 150 seconds
Peak Temperature ( $T_P$ )		260 <sup>+0/-5</sup> °C
Time of within 5 °C of Actual Peak Temperature ( $t_p$ )		20 ~ 40 seconds
Ramp-down Rate		6 °C / second max.
Time from 25 °C to Peak Temperature		8 Minutes max.
Do Not Exceed		260 °C

Packaging Information

Tape	Symbol	Dimension (mm)
	W	16.00+0.3/-0.1
	P <sub>0</sub>	4.00±0.10
	P <sub>1</sub>	8.00±0.10
	P <sub>2</sub>	2.00±0.10
	D <sub>0</sub>	1.55±0.05
	D <sub>1</sub>	1.55±0.05
	E	1.75±0.10
	F	7.50±0.10
	A <sub>0</sub>	6.15±0.10
	B <sub>0</sub>	8.30±0.10
	K <sub>0</sub>	2.48±0.10
	T	0.30±0.05

Reel Size	13" Reel	
	A	330 mm
	C	13.2 mm
	W <sub>1</sub>	16.4 mm

Part Number	Package	QTY (Reel)	Packaging Option	Packaging Specification
A5.0SMDxxx	DO-214AB	3000 PCS	Tape & Reel – 16 mm tape/13" reel	EIA STD RS-481



# ATTENTION

## Usage

1. TVS must be operated in the specified ambient temp.
2. Do not clean the TVS with strong polar solvent such as ketone, esters, benzene and halogenated hydrocarbon, to avoid damaging the encapsulating layer.
3. Please do not apply severe vibration, shock or pressure to TVS, to avoid element cracking.

## Replacement

1. If TVS is visually damaged, please replace it.
2. TVS is a non-repairable product. For safety sake, please use equivalent TVS for replacement.

## Storage

1. Storage Temp. Range: (-55 to 150) °C.
2. Do not store the TVS at the high temp., high humidity or corrosive gas environment, to avoid influencing the solder-ability of the lead wires. The product shall be used up within 1 year after receiving the goods.

## Environmental Conditions

1. TVS should not be exposed to the open air, nor direct sunshine.
2. TVS should avoid rain, water vapor or other condition of high temp. and high humidity.
3. TVS should avoid sand dust, salt mist, or other harmful gases.

## Max. Typical Capacitance of TVS

The typical capacitance of TVS is listed in the specifications. Designers may refer to it when designing TVS in High frequency circuit.

## Installation Mechanical Stress

1. Do not knock TVS when installing, to avoid mechanical damage.
2. Please do not apply severe vibration, shock or pressure to TVS, to avoid surface resin or element cracking.