

TVS Diodes

Transient Voltage Suppression Diodes

SMF Series

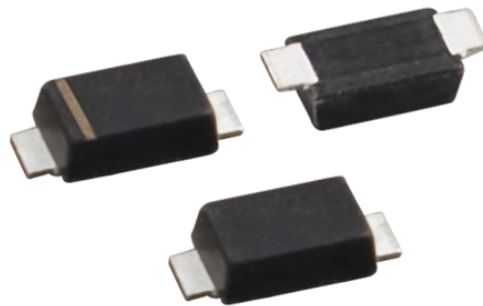

Description

The SMF series is designed specifically to protect sensitive electronic equipment from voltage transients induced by lightning and other transient voltage events. SMF package is 50% smaller in footprint when compared to SMA package and delivering one of the low height profiles (1.2mm) in the industry.

Applications

- Communication Equipment
- Security & Protection
- Industrial Control Equipment
- Power Supply
- Automotive Electronics
- New Energy
- Lightning Protection

Functional Diagram

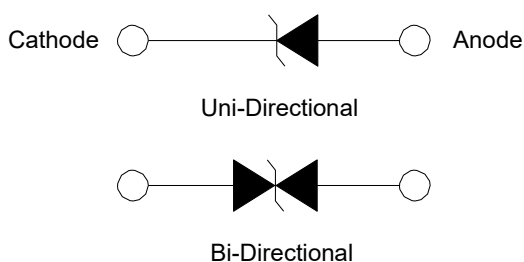

Features

- 200 W peak pulse capability at 10/1000 μ S waveform, repetition rate (duty cycles):0.01%
- Compatible with industrial standard package SOD-123FL
- Low profile: maximum height of 1.2 mm
- Low inductance, excellent clamping capability
- For surface mounted applications to optimize board space
- High temperature to reflow soldering guaranteed: 260 °C / 40 sec
- Typical failure mode is short from over-specified voltage or current
- Whisker test is conducted based on JEDEC JESD201A per its table 4a and 4c
- IEC-61000-4-2 ESD 30 kV (Air), 30 kV (Contact)
- ESD protection of data lines in accordance with IEC 61000-4-2
- EFT protection of data lines in accordance with IEC 61000-4-4
- Fast response time: typically less than 1.0 ns from 0 Volts to V_{BR} min
- Glass passivated junction
- Built-in strain relief
- Plastic package is flammability rated V-0 per UL 94
- Meet MSL level1, per J-STD-020
- Matte tin lead-free plated
- Halogen-free and RoHS compliant
- Pb-free E3 means 2nd level interconnect is Pb-free and the terminal finish material is tin(Sn) (IPC/ JEDEC J-STD-609A.01)

TVS Diodes

Transient Voltage Suppression Diodes

SMF Series

Package Outline Dimensions (SOD-123FL)

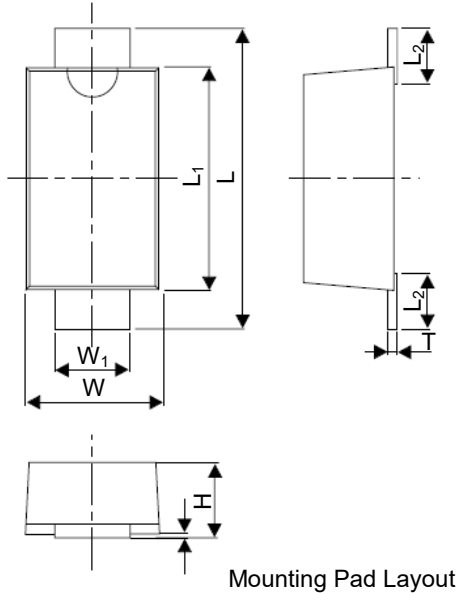

Symbol	Millimeters		Inches	
	Min.	Max.	Min.	Max.
L ₁	2.70	2.90	0.1060	0.1140
L	3.40	3.90	0.1339	0.1535
W ₁	0.70	1.20	0.0275	0.0472
W	1.50	2.00	0.0591	0.0787
L ₂	0.35	0.90	0.0138	0.0354
T	0.05	0.26	0.0020	0.0102
H	1.20	1.40	0.0470	0.0550

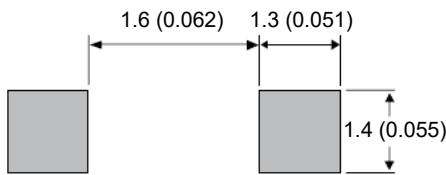

SOD-123FL

Maximum Ratings and Characteristics

(T_A = 25 °C unless otherwise specified.)

Parameter	Symbol	Value	Unit
Peak Pulse Power Dissipation at T _A =25 °C (Note 1)	P _{PPM}	8/20 μS	1000
		10/1000 μS (Note 2)	200
Power Dissipation On Infinite Heat Sink at T _L =50 °C	P _D	1	W
Thermal Resistance Junction- to- Ambient	R _{θJA}	220	°C / W
Thermal Resistance Junction- to- Lead	R _{θJL}	100	°C / W
Operating Temperature Range	T _J	-65 to 150	°C
Storage Temperature Range	T _{STG}	-65 to 175	°C

Notes

1. Non-repetitive current pulse, per Fig. 4 and derated above T_J(initial)=25 °C per Fig. 3.
2. SMF90A~SMF100A Peak Pulse Power Dissipation is 170 W min, 200 W typical @ 10/1000 uS.

TVS Diodes

Transient Voltage Suppression Diodes

SMF Series

Part Numbering System

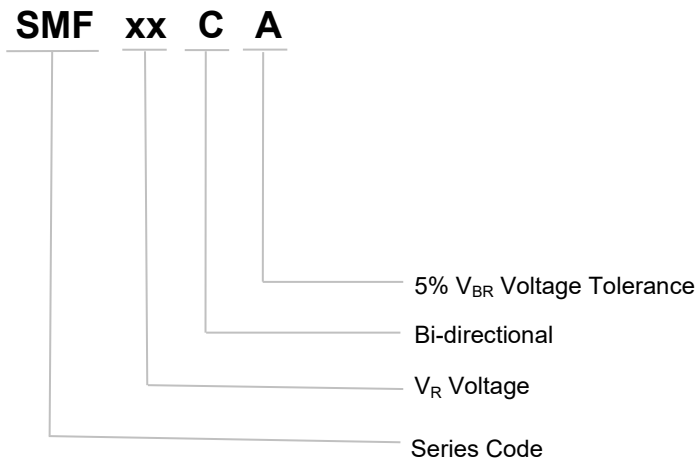

Marking

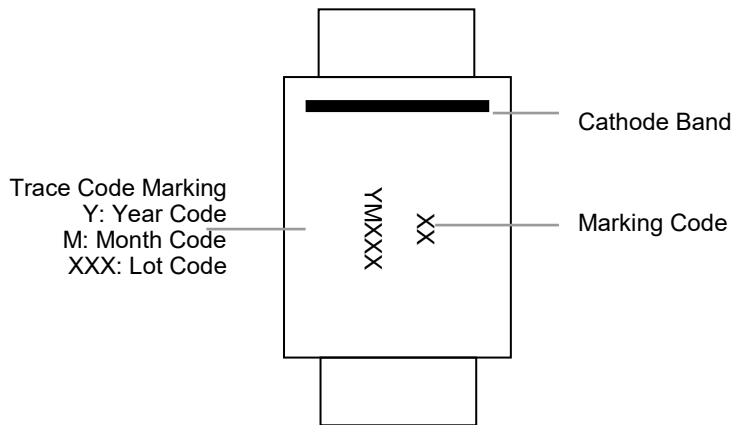

Glossary

Item	Description
V_C	Clamping Voltage Voltage across TVS in a region of low differential resistance that serves to limit the voltage across the device terminals.
V_R	Reverse Stand-off Voltage Maximum voltage that can be applied to the TVS without operation. NOTE : It is also shown as V_{WM} (maximum working voltage (maximum d.c. voltage)) and known as rated stand-off voltage (V_{so}).
I_R	Reverse Leakage Current Current measured at V_R .
V_{BR}	Breakdown Voltage Voltage across TVS at a specified current I_T in the breakdown region.
I_{PPM}	Rated Random Recurring Peak Impulse Current Maximum-rated value of random recurring peak impulse current that may be applied to a device.
$P_{M(AV)}$	Rated Average Power Dissipation Maximum-rated value of power dissipation resulting from all sources, including transients and standby current, averaged over a short period of time.
P_{PPM}	Rated Random Recurring Peak Impulse Power Dissipation Maximum-rated value of the product of rated random recurring peak impulse current (I_{PPM}) multiplies by specified maximum clamping voltage (V_C).
C_J	Capacitance Capacitance across the TVS measured at a specified frequency and voltage.
V_{FS}	Peak Forward Surge Voltage Peak voltage across an TVS for a specified forward surge current (I_{FS}) and time duration. NOTE : Also shown as V_F .
I_{FS}	Forward Surge Current Pulsed current through TVS in the forward conducting region. NOTE : Also shown as I_F .
$\alpha_{V(BR)}$	Temperature Coefficient of Breakdown Voltage The change of breakdown voltage divided by the change of temperature.
I_{PP}	Peak pulse Current Peak pulse current value applied across the TVS to determine the clamping voltage V_C for a specified wave shape.
I_T	Pulsed D.C. Test Current Test current for measurement of the breakdown voltage V_{BR} . This is defined by the manufacturer and usually given in milliamperes with a pulse duration of less than 40 ms. NOTE : Also shown as I_{BR} .

—(GB-T 18802.321 / IEC 61643-321 / JESD210A)

TVS Diodes

Transient Voltage Suppression Diodes

SMF Series

Electrical Characteristics (T_A=25 °C unless otherwise noted)Table 1

Part Number		Device Marking Code		Breakdown Voltage V _{BR} @I _T		Test Current I _T	Reverse Stand-off Voltage V _R	Max. Reverse Leakage I _r @V _R	Max. Peak Pulse Current I _{PPM}	Max. Clamping Voltage V _C @I _{PPM}
				Min	Max					
Uni	Bi	Uni	Bi	(V)		(mA)	(V)	(μA)	(A)	(V)
SMF3.3A	-	UZ	-	5.2	6.0	10	3.3	50	25	8.0
SMF5.0A	SMF5.0CA	AE	HE	6.40	7.00	10	5.0	400	21.7	9.2
SMF6.0A	SMF6.0CA	AG	HG	6.67	7.37	10	6.0	400	19.4	10.3
SMF6.5A	SMF6.5CA	AK	HK	7.22	7.98	10	6.5	250	17.9	11.2
SMF7.0A	SMF7.0CA	AM	HM	7.78	8.60	10	7.0	100	16.7	12.0
SMF7.5A	SMF7.5CA	AP	HP	8.33	9.21	1	7.5	50	15.5	12.9
SMF8.0A	SMF8.0CA	AR	HR	8.89	9.83	1	8.0	25	14.7	13.6
SMF8.5A	SMF8.5CA	AT	HT	9.44	10.40	1	8.5	10	13.9	14.4
SMF9.0A	SMF9.0CA	AV	HV	10.00	11.10	1	9.0	2.5	13.0	15.4
SMF10A	SMF10CA	AX	HX	11.10	12.30	1	10	2.5	11.8	17.0
SMF11A	SMF11CA	AZ	HZ	12.20	13.50	1	11	2.5	11.0	18.2
SMF12A	SMF12CA	BE	IE	13.30	14.70	1	12	2.5	10.1	19.9
SMF13A	SMF13CA	BG	IG	14.40	15.90	1	13	1.0	9.3	21.5
SMF14A	SMF14CA	BK	IK	15.60	17.20	1	14	1.0	8.6	23.2
SMF15A	SMF15CA	BM	IM	16.70	18.50	1	15	1.0	8.2	24.4
SMF16A	SMF16CA	BP	IP	17.80	19.70	1	16	1.0	7.7	26.0
SMF17A	SMF17CA	BR	IR	18.90	20.90	1	17	1.0	7.2	27.6
SMF18A	SMF18CA	BT	IT	20.00	22.10	1	18	1.0	6.8	29.2
SMF20A	SMF20CA	BV	IV	22.20	24.50	1	20	1.0	6.2	32.4
SMF22A	SMF22CA	BX	IX	24.40	26.90	1	22	1.0	5.6	35.5
SMF24A	SMF24CA	BZ	IZ	26.70	29.50	1	24	1.0	5.1	38.9
SMF26A	SMF26CA	CE	JE	28.90	31.90	1	26	1.0	4.8	42.1
SMF28A	SMF28CA	CG	JG	31.10	34.40	1	28	1.0	4.4	45.4
SMF30A	SMF30CA	CK	JK	33.30	36.80	1	30	1.0	4.1	48.4
SMF33A	SMF33CA	CM	JM	36.70	40.60	1	33	1.0	3.8	53.3
SMF36A	SMF36CA	CP	JP	40.00	44.20	1	36	1.0	3.4	58.1

TVS Diodes

Transient Voltage Suppression Diodes

SMF Series

Part Number		Device Marking Code		Breakdown Voltage $V_{BR}@I_T$		Test Current I_T	Reverse Stand-off Voltage V_R	Max. Reverse Leakage $I_R@V_R$	Max. Peak Pulse Current I_{PPM}	Max. Clamping Voltage $V_C@I_{PPM}$
				Min	Max					
Uni	Bi	Uni	Bi	(V)		(mA)	(V)	(μ A)	(A)	(V)
SMF40A	SMF40CA	CR	JR	44.40	49.10	1	40	1.0	3.1	64.5
SMF43A	SMF43CA	CT	JT	47.80	52.80	1	43	1.0	2.9	69.4
SMF45A	SMF45CA	CV	JV	50.00	55.30	1	45	1.0	2.8	72.7
SMF48A	SMF48CA	CX	JX	53.30	58.90	1	48	1.0	2.6	77.4
SMF51A	SMF51CA	CZ	JZ	56.70	62.70	1	51	1.0	2.4	82.4
SMF54A	SMF54CA	DE	KE	60	66.3	1	54	1.0	2.3	87.1
SMF58A	SMF58CA	RG	KG	64.4	71.2	1	58	1.0	2.1	93.6
SMF60A	SMF60CA	RK	KK	66.7	73.7	1	60	1.0	2.1	96.8
SMF64A	SMF64CA	RM	KM	71.1	78.6	1	64	1.0	1.9	103.0
SMF70A	SMF70CA	RP	KP	77.8	86	1	70	1.0	1.7	113.0
SMF75A	SMF75CA	RR	KR	83.3	92.1	1	75	1.0	1.6	121.0
SMF78A	SMF78CA	RT	KT	86.7	95.8	1	78	1.0	1.6	126.0
SMF85A	SMF85CA	RV	KV	94.4	104	1	85	1.0	1.5	137.0
SMF90A	-	RW	-	100	111	1	90	1.0	1.2	146.0
SMF100A	-	RX	-	111	123	1	100	1.0	1.1	162.0
SMF110A	-	SE	-	122	135	1	110	1.0	1.1	177.0
SMF120A	-	SG	-	133	147	1	120	1.0	1.0	193.0
SMF130A	-	SK	-	144	159	1	130	1.0	1.0	209.0
SMF150A	-	SM	-	167	185	1	150	1.0	0.8	243.0
SMF160A	-	SP	-	178	197	1	160	1.0	0.8	259.0
SMF170A	-	SR	-	189	209	1	170	1.0	0.7	275.0
SMF180A	-	ST	-	201	222	1	180	1.0	0.7	292.0
SMF188A	-	SV	-	209	231	1	188	1.0	0.7	304
SMF200A	-	SX	-	224	247	1	200	1.0	0.6	324
SMF220A	-	SZ	-	246	272	1	220	1.0	0.6	356
SMF250A	-	TE	-	279	309	1	250	1.0	0.5	405

Notes:

1. V_{BR} measured after I_T applied for 300 μ S, I_T = square wave pulse or equivalent.
2. Surge current waveform per 10/1000 μ S exponential wave and derated per Fig.2.
3. All terms and symbols are consistent with ANSI/IEEE C62.35.
4. For bidirectional type having V_R of 10 volts and less, the I_R should be doubled.

TVS Diodes

Transient Voltage Suppression Diodes

SMF Series

I-V Curve Characteristics

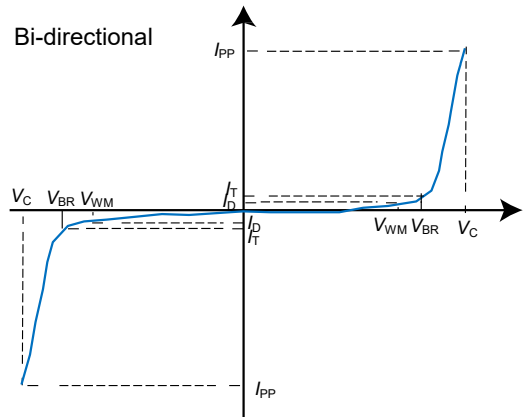
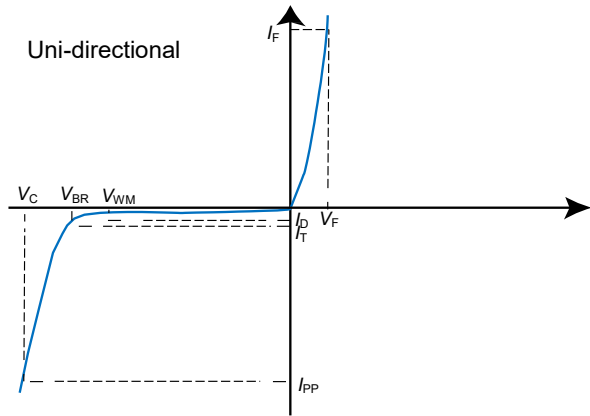

Performance Curve for Reference ($T_A=25^\circ\text{C}$ unless otherwise noted)

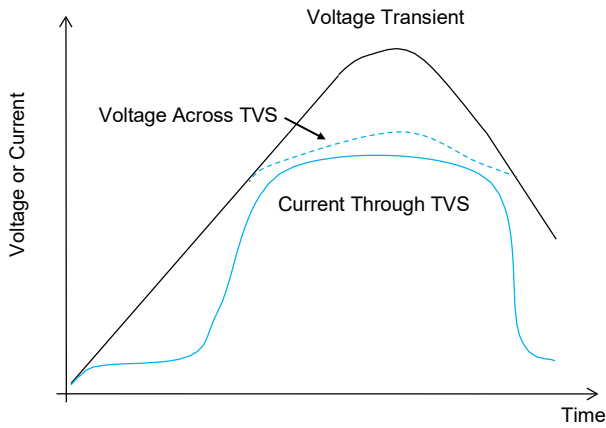

FIGURE 1 TVS Transients Clamping Waveform

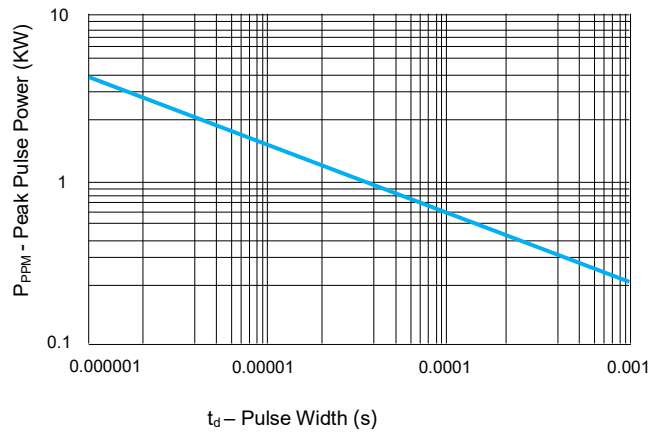

FIGURE 2 Peak Pulse Power Rating Curve

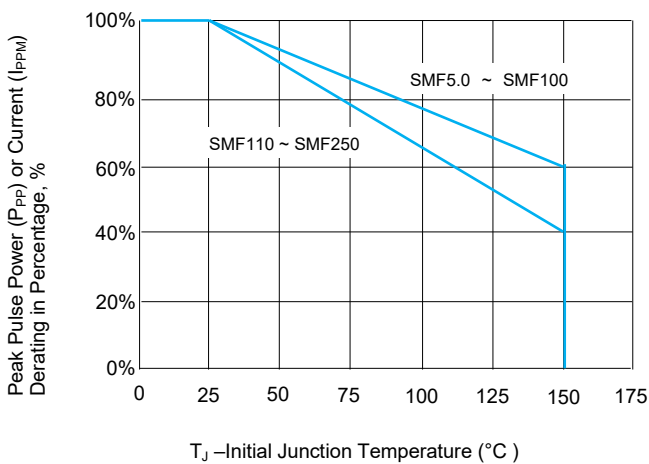

FIGURE 3 Peak Pulse Power Derating Curve

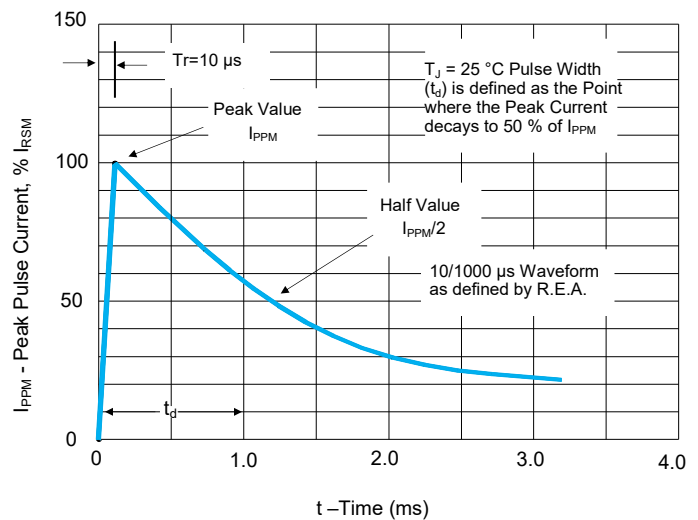

FIGURE 4 Pulse Waveform - 10/1000 μs

TVS Diodes

Transient Voltage Suppression Diodes

SMF Series

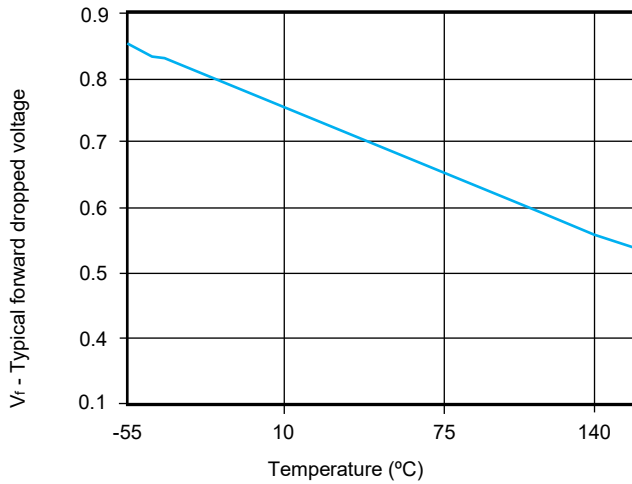

FIGURE 5 Forward Voltage

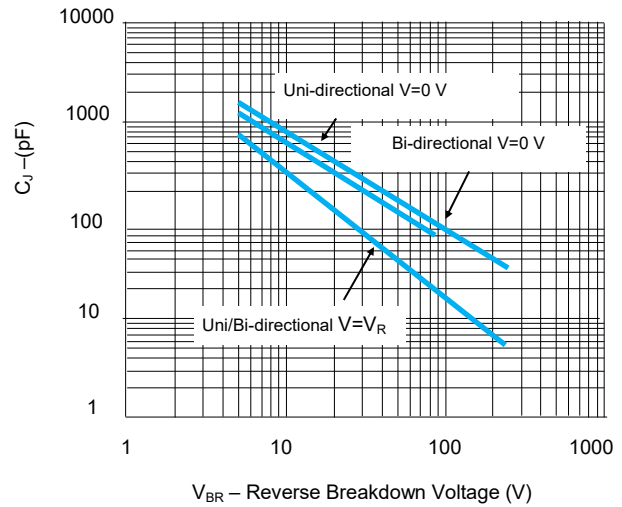

FIGURE 6 Typical Junction Capacitance

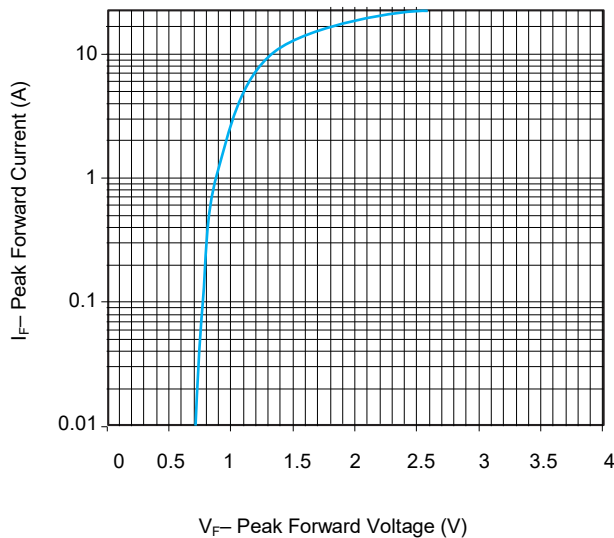

FIGURE 7 Peak Forward Drop vs Peak Forward Current (Typical Values)

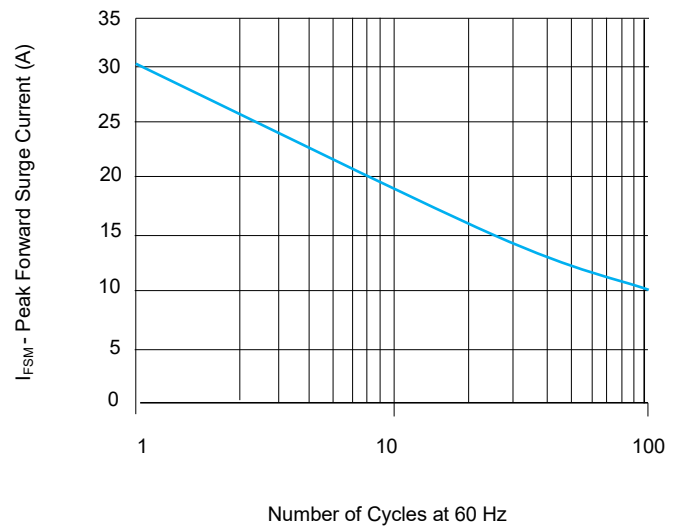

FIGURE 8 Maximum Non-Repetitive Forward Surge Current Uni-Directional only

Environmental Specifications

High Temp. Storage	JESD22-A103
HTRB	JESD22-A108
Temperature Cycling	JESD22-A104
MSL	JEDEC-J-STD-020, Level 1
H3TRB	JESD22-A101
RSH	JESD22-A111

Physical Specifications

Case	SOD-123FL plastic over glass passivated junction
Polarity	Color band denotes cathode except bipolar
Terminal	Matte tin-plated leads, solderable per JESD22-B102

Soldering Parameters

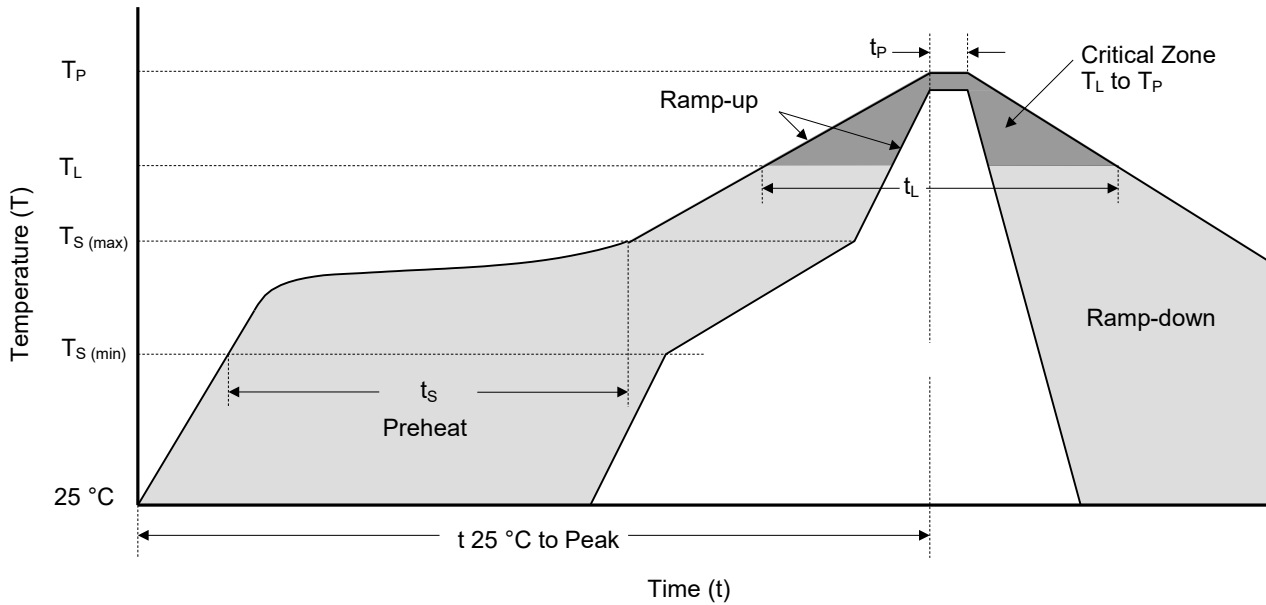

Reflowing Condition

Reflow Soldering Parameters		Lead-Free Assembly
Pre-heat	Temperature Min ($T_{S(min)}$)	150 °C
	Temperature Max ($T_{S(max)}$)	200 °C
	Time (min to max) (t_s)	60 ~ 120 seconds
Average Ramp Up Rate (Liquidus Temp (T_L) to Peak)		3 °C / second max.
$T_{S(max)}$ to T_L Ramp-up Rate		3 °C / second max.
Reflow	Temperature (T_L) (Liquidus)	217 °C
	Time (min to max) (t_L)	60 ~ 150 seconds
Peak Temperature (T_P)		260 ^{+0/-5} °C
Time of within 5 °C of Actual Peak Temperature (t_p)		20 ~ 40 seconds
Ramp-down Rate		6 °C / second max.
Time from 25 °C to Peak Temperature		8 Minutes max.
Do Not Exceed		260 °C

TVS Diodes

Transient Voltage Suppression Diodes

SMF Series

Packaging Information

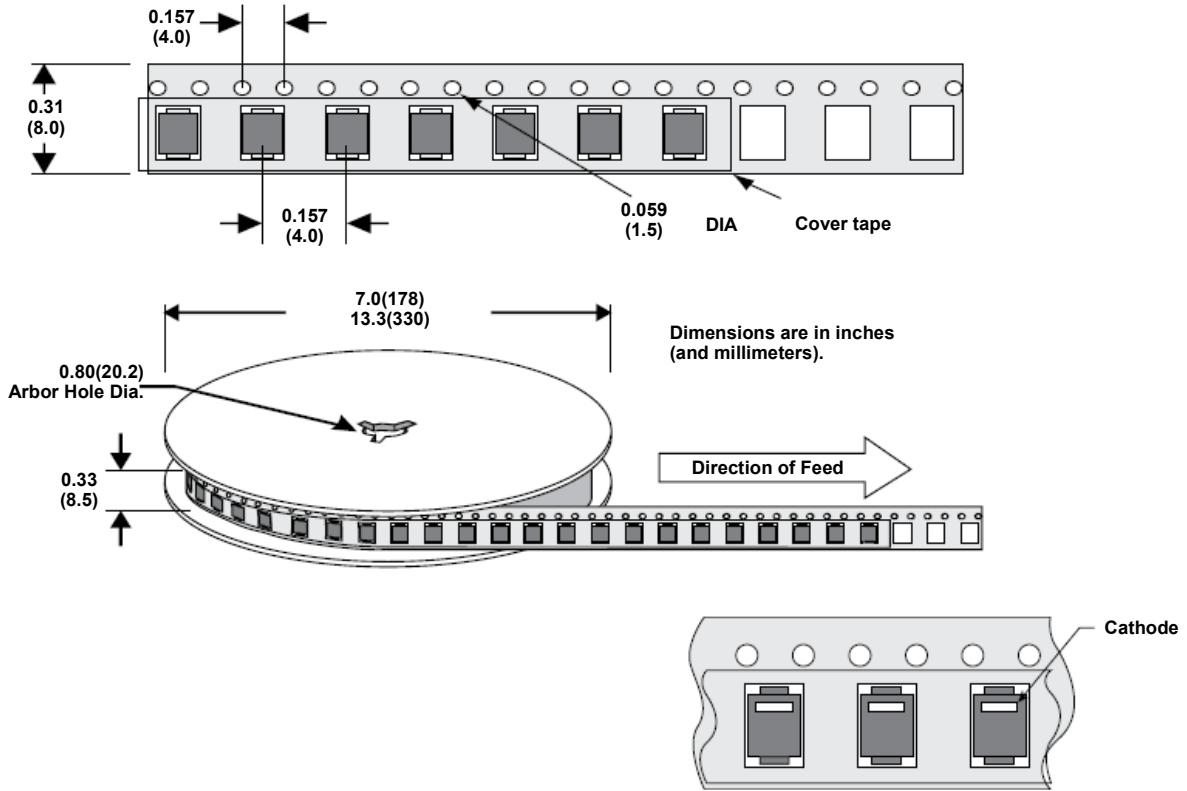

Part Number	Package	QTY' s (Reel)	Packaging Option	Packaging Specification
SMFXXX	SOD-123FL	3000 PCS	Tape & Reel – 8 mm tape/7" reel	EIA RS-481



ATTENTION

Usage

1. TVS must be operated in the specified ambient temp.
2. Do not clean the TVS with strong polar solvent such as ketone, esters, benzene and halogenated hydrocarbon, to avoid damaging the encapsulating layer.
3. Please do not apply severe vibration, shock or pressure to TVS, to avoid element cracking.

Replacement

1. If TVS is visually damaged, please replace it.
2. TVS is a non-repairable product. For safety sake, please use equivalent TVS for replacement.

Storage

1. Storage Temp. Range: (-55 to 150) °C.
2. Do not store the TVS at the high temp., high humidity or corrosive gas environment, to avoid influencing the solder-ability of the lead wires. The product shall be used up within 1 year after receiving the goods.

Environmental Conditions

1. TVS should not be exposed to the open air, nor direct sunshine.
2. TVS should avoid rain, water vapor or other condition of high temp. and high humidity.
3. TVS should avoid sand dust, salt mist, or other harmful gases.

Max. Typical Capacitance of TVS

The typical capacitance of TVS is listed in the specifications. Designers may refer to it when designing TVS in High frequency circuit.

Installation Mechanical Stress

1. Do not knock TVS when installing, to avoid mechanical damage.
2. Please do not apply severe vibration, shock or pressure to TVS, to avoid surface resin or element cracking.