

TVS Diodes

Transient Voltage Suppression Diodes

SMAJ Series



TVS

TVS

Description

Transient Voltage Suppressor (TVS) is a circuit protection component that either attenuates (reduces) or filters a transient voltage spike (overvoltage), TVS diodes provide critical protection by going into avalanche breakdown within no more than a few nanoseconds after a strike, clamping the transient voltage, and routing its current to the ground.

Applications

- Communication Equipment
- Security & Protection
- Industrial Control Equipment
- Power Supply
- Automotive Electronics
- New Energy
- Lightning Protection

Functional Diagram



Uni-Directional



Bi-Directional

Features

- Low incremental surge resistance
- Excellent clamping capability
- Low profile package with built-in strain relief
- Typical I_R less than 1.0 μA above 12 V
- 400 W peak pulse power capability with a 10/1000 μS Waveform, repetition rate (duty cycle): 0.01%
- For surface mounted applications to optimize board space
- Typical failure mode is short from over-specified voltage or current
- IEC 61000-4-2 ESD 30 kV (Air), 30 kV (Contact)
- EFT protection of data lines in accordance with IEC 61000 -4-4
- Very fast response time
- Glass passivated chip junction or Planar chip (< 10 V)
- High temperature to reflow soldering guaranteed: 260 $^{\circ}\text{C}/30$ sec
- $V_{BR} @ T_J = V_{BR}@25^{\circ}\text{C} \times (1 + \alpha T \times (T_J - 25))$
(αT : Temperature Coefficient, typical value is 0.1%)
- Plastic package is flammability rated V-0 per Underwriters Laboratories
- Meet MSL level1, per J-STD-020
- Matte tin lead-free plated
- Halogen free and RoHS compliant
- Pb-free E3 means 2nd level interconnect is Pb-free and the terminal finish material is tin(Sn) (IPC/JEDEC J-STD-609A.01)

TVS Diodes

Transient Voltage Suppression Diodes

SMAJ Series

Package Outline Dimensions (DO-214AC)

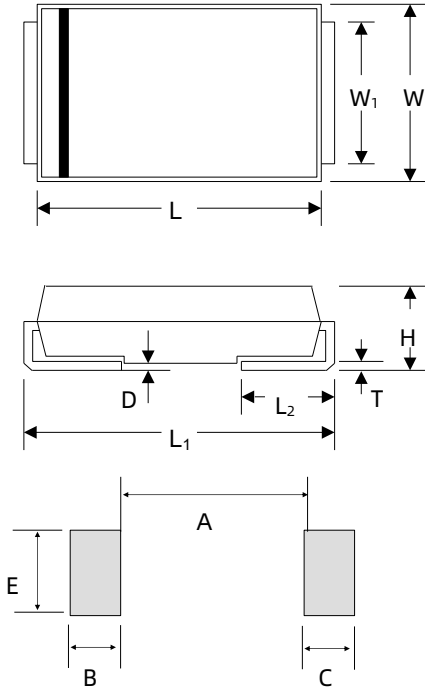

(Mounting Pad Layout)

Symbol	Millimeters		Inches	
	Min.	Max.	Min.	Max.
L	3.99	4.60	0.157	0.181
W	2.30	2.79	0.095	0.110
W ₁	1.25	1.65	0.049	0.065
H	1.90	2.44	0.075	0.096
T	0.152	0.305	0.006	0.012
L ₁	4.80	5.28	0.189	0.208
L ₂	0.78	1.52	0.030	0.060
D	-	0.203	-	0.008
A	-	2.30	-	0.090
B	2.10	-	0.082	-
C	2.10	-	0.082	-
E	1.80	-	0.070	-

TVS

TVS

Maximum Ratings and Characteristics

(Ratings at 25 °C ambient temperature unless otherwise specified.)

Parameter	Symbol	Value	Unit
Peak Power Dissipation (Fig2) with a 10/1000 μ S waveform ⁽¹⁾⁽²⁾ (Fig4)-Signal Die Parts	P _{PPM}	400	W
Peak Power Dissipation (Fig2) with a 10/1000 μ S waveform ⁽¹⁾⁽²⁾ (Fig.4)-Stacked Die Parts ⁽⁵⁾	P _{PPM}	600	W
Peak Power Dissipation on Infinite Heat Sink at T _L =50 °C	P _D	3.3	W
Peak Forward Surge Current,8.3 ms single half sinewave superimposed on rated load (JEDEC Method) ⁽³⁾	I _{FSM}	60	A
Maximum Instantaneous Forward Voltage at 25 A for Unidirectional Only ⁽⁴⁾	V _F	3.5/5.0	V
Operating Temperature Range	T _J	-65 to 150	°C
Storage Temperature Range	T _{STG}	-65 to 175	°C
Typical Thermal Resistance Junction to Lead	R _{θJL}	30	°C / W
Typical Thermal Resistance Junction to Ambient	R _{θJA}	120	°C / W

Notes

1. Non-repetitive current pulse, per Fig. 4 and derated above T_J(initial)=25°C per Fig. 3.
2. Mounted on 5.0 mm² land areas.
3. Measured of 8.3 ms single half sine-wave or equivalent square wave, duty cycle=4 pulses per minute maximum.
4. V_F < 3.5 V for single die parts and V_F < 5.0 V for stacked-die parts.
5. For stacked die component details, please refer to part numbers labeled by * in Electrical Characteristics.

TVS Diodes

Transient Voltage Suppression Diodes

SMAJ Series

Part Numbering System

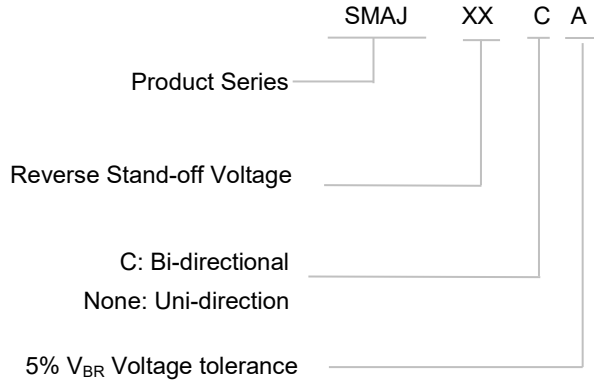

Marking

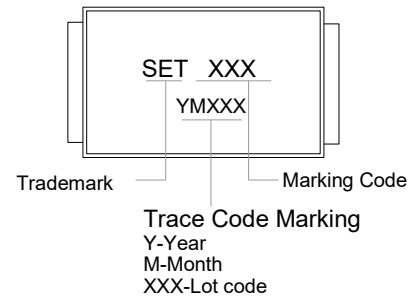
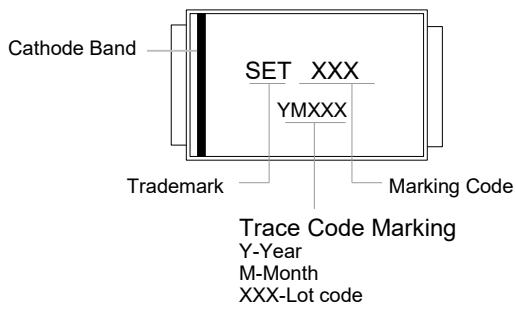

Glossary

Item	Description
V_C	Clamping Voltage Voltage across TVS in a region of low differential resistance that serves to limit the voltage across the device terminals.
V_R	Reverse Stand-off Voltage Maximum voltage that can be applied to the TVS without operation. NOTE : It is also shown as V_{WM} (maximum working voltage (maximum d.c. voltage)) and known as rated stand-off voltage (V_{so}).
I_R	Reverse Leakage Current Current measured at V_R . NOTE : Also shown as I_D for stand-by current.
V_{BR}	Breakdown Voltage Voltage across TVS at a specified current I_T in the breakdown region.
I_{PPM}	Rated Random Recurring Peak Impulse Current Maximum-rated value of random recurring peak impulse current that may be applied to a device.
$P_{M(AV)}$	Rated Average Power Dissipation Maximum-rated value of power dissipation resulting from all sources, including transients and standby current, averaged over a short period of time.
P_{PPM}	Rated Random Recurring Peak Impulse Power Dissipation Maximum-rated value of the product of rated random recurring peak impulse current (I_{PPM}) multiplies by specified maximum clamping voltage (V_C).
C_J	Capacitance Capacitance across the TVS measured at a specified frequency and voltage.
V_{FS}	Peak Forward Surge Voltage Peak voltage across an TVS for a specified forward surge current (I_{FS}) and time duration. NOTE : Also shown as V_F .
I_{FS}	Forward Surge Current Pulsed current through TVS in the forward conducting region. NOTE : Also shown as I_F .
$\alpha_{V(BR)}$	Temperature Coefficient of Breakdown Voltage The change of breakdown voltage divided by the change of temperature.
I_{PP}	Peak pulse Current Peak pulse current value applied across the TVS to determine the clamping voltage V_C for a specified wave shape.
I_T	Pulsed D.C. Test Current Test current for measurement of the breakdown voltage V_{BR} . This is defined by the manufacturer and usually given in milliamperes with a pulse duration of less than 40 ms. NOTE : Also shown as I_{BR} .

—(GB-T 18802.321 / IEC 61643-321 / JESD210A)

Electrical Characteristics (T_A=25 °C unless otherwise noted)Table 1

Part Number		Device Marking Code		Breakdown Voltage V _{BR} @I _T		Test Current I _T	Reverse Stand-off Voltage V _R	Max. Reverse Leakage I _R @V _R	Max. Peak Pulse Current I _{PPM}	Max. Clamping Voltage V _C @I _{PPM}
				Min	Max					
Uni	Bi	Uni	Bi	(V)		(mA)	(V)	(μA)	(A)	(V)
SMAJ5.0A	SMAJ5.0CA	AE	WE	6.4	7	10	5	800	43.5	9.2
SMAJ6.0A	SMAJ6.0CA	AG	WG	6.67	7.37	10	6	800	38.8	10.3
SMAJ6.5A	SMAJ6.5CA	AK	WK	7.22	7.98	10	6.5	500	35.7	11.2
SMAJ7.0A	SMAJ7.0CA	AM	WM	7.78	8.6	10	7	200	33.3	12
SMAJ7.5A	SMAJ7.5CA	AP	WP	8.33	9.21	1	7.5	100	31	12.9
SMAJ8.0A	SMAJ8.0CA	AR	WR	8.89	9.83	1	8	50	29.4	13.6
SMAJ8.5A	SMAJ8.5CA	AT	WT	9.44	10.4	1	8.5	20	27.8	14.4
SMAJ9.0A	SMAJ9.0CA	AV	WV	10	11.1	1	9	10	26	15.4
SMAJ10A	SMAJ10CA	AX	WX	11.1	12.3	1	10	5	23.5	17
SMAJ11A	SMAJ11CA	AZ	WZ	12.2	13.5	1	11	1	22	18.2
SMAJ12A	SMAJ12CA	BE	XE	13.3	14.7	1	12	1	20.1	19.9
SMAJ13A	SMAJ13CA	BG	XG	14.4	15.9	1	13	1	18.6	21.5
SMAJ14A	SMAJ14CA	BK	XK	15.6	17.2	1	14	1	17.2	23.2
SMAJ15A	SMAJ15CA	BM	XM	16.7	18.5	1	15	1	16.4	24.4
SMAJ16A	SMAJ16CA	BP	XP	17.8	19.7	1	16	1	15.4	26
SMAJ17A	SMAJ17CA	BR	XR	18.9	20.9	1	17	1	14.5	27.6
SMAJ18A	SMAJ18CA	BT	XT	20	22.1	1	18	1	13.7	29.2
SMAJ20A	SMAJ20CA	BV	XV	22.2	24.5	1	20	1	12.3	32.4
SMAJ22A	SMAJ22CA	BX	XX	24.4	26.9	1	22	1	11.3	35.5
SMAJ24A	SMAJ24CA	BZ	XZ	26.7	29.5	1	24	1	10.3	38.9
SMAJ26A	SMAJ26CA	CE	YE	28.9	31.9	1	26	1	9.5	42.1
SMAJ28A	SMAJ28CA	CG	YG	31.1	34.4	1	28	1	8.8	45.4
SMAJ30A	SMAJ30CA	CK	YK	33.3	36.8	1	30	1	8.3	48.4
SMAJ33A	SMAJ33CA	CM	YM	36.7	40.6	1	33	1	7.5	53.3
SMAJ36A	SMAJ36CA	CP	YP	40	44.2	1	36	1	6.9	58.1
SMAJ40A	SMAJ40CA	CR	YR	44.4	49.1	1	40	1	6.2	64.5
SMAJ43A	SMAJ43CA	CT	YT	47.8	52.8	1	43	1	5.8	69.4
SMAJ45A	SMAJ45CA	CV	YV	50	55.3	1	45	1	5.5	72.7
SMAJ48A	SMAJ48CA	CX	YX	53.3	58.9	1	48	1	5.2	77.4
SMAJ51A	SMAJ51CA	CZ	YZ	56.7	62.7	1	51	1	4.9	82.4
SMAJ54A	SMAJ54CA	RE	ZE	60	66.3	1	54	1	4.6	87.1

TVS

TVS

TVS Diodes

Transient Voltage Suppression Diodes

SMAJ Series

Part Number		Device Marking Code		Breakdown Voltage $V_{BR}@I_T$		Test Current I_T	Reverse Stand-off Voltage V_R	Max. Reverse Leakage $I_R@V_R$	Max. Peak Pulse Current I_{PP}	Max. Clamping Voltage $V_C@I_{PP}$
				Min	Max					
Uni	Bi	Uni	Bi	(V)		(mA)	(V)	(μ A)	(A)	(V)
SMAJ58A	SMAJ58CA	RG	ZG	64.4	71.2	1	58	1	4.3	93.6
SMAJ60A	SMAJ60CA	RK	ZK	66.7	73.7	1	60	1	4.1	96.8
SMAJ64A	SMAJ64CA	RM	ZM	71.1	78.6	1	64	1	3.9	103
SMAJ70A	SMAJ70CA	RP	ZP	77.8	86	1	70	1	3.5	113
SMAJ75A	SMAJ75CA	RR	ZR	83.3	92.1	1	75	1	3.3	121
SMAJ78A	SMAJ78CA	RT	ZT	86.7	95.8	1	78	1	3.2	126
SMAJ85A	SMAJ85CA	RV	ZV	94.4	104	1	85	1	2.9	137
SMAJ90A	SMAJ90CA	RX	ZX	100	111	1	90	1	2.7	146
SMAJ100A	SMAJ100CA	RZ	ZZ	111	123	1	100	1	2.5	162
SMAJ110A	SMAJ110CA	SE	VE	122	135	1	110	1	2.3	177
SMAJ120A	SMAJ120CA	SG	VG	133	147	1	120	1	2.1	193
SMAJ130A	SMAJ130CA	SK	VK	144	159	1	130	1	1.9	209
SMAJ150A	SMAJ150CA	SM	VM	167	185	1	150	1	1.6	243
SMAJ160A	SMAJ160CA	SP	VP	178	197	1	160	1	1.5	259
SMAJ170A	SMAJ170CA	SR	VR	189	209	1	170	1	1.5	275
SMAJ180A	SMAJ180CA	ST	VT	201	222	1	180	1	1.4	292
SMAJ188A	SMAJ188CA	SB	VB	209	231	1	188	1	1.4	304
SMAJ200A	SMAJ200CA	SV	VV	224	247	1	200	1	1.2	324
SMAJ220A	-	SX	-	246	272	1	220	1	1.1	356
-	SMAJ220CA*	-	VX	246	272	1	220	1	1.1	356
SMAJ250A	-	SZ	-	279	309	1	250	1	1.0	405
-	SMAJ250CA*	-	VZ	279	309	1	250	1	1.0	405
SMAJ300A*	SMAJ300CA*	TE	UE	335	371	1	300	1	0.8	486
SMAJ350A*	SMAJ350CA*	TG	UG	391	432	1	350	1	0.7	567
SMAJ400A*	SMAJ400CA*	TK	UK	447	494	1	400	1	0.6	648
SMAJ440A*	SMAJ440CA*	TM	UM	492	543	1	440	1	0.6	713

Notes:

1. For bidirectional type having V_R of 10 volts and less, the I_R should be doubled.
2. For parts without A in the PN, the V_{BR} tolerance is $\pm 10\%$ and V_C is 5% higher than parts with A. The parts without A are currently available, but not recommended for new designs. The parts with A are preferred.
3. For stacked die component details, please refer to models marked with * in electrical characteristics table.

TVS Diodes

Transient Voltage Suppression Diodes

SMAJ Series

I-V Curve Characteristics

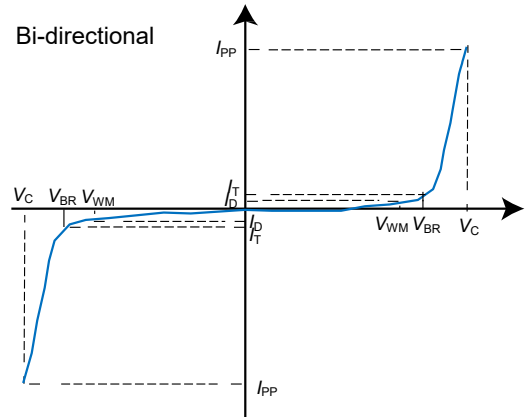
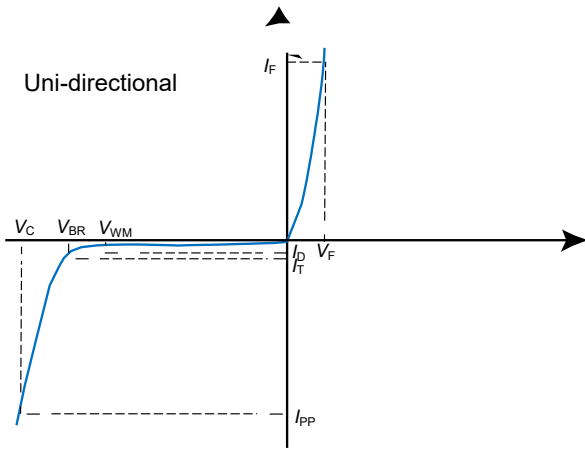

Performance Curve for Reference ($T_A=25^\circ\text{C}$ unless otherwise noted)

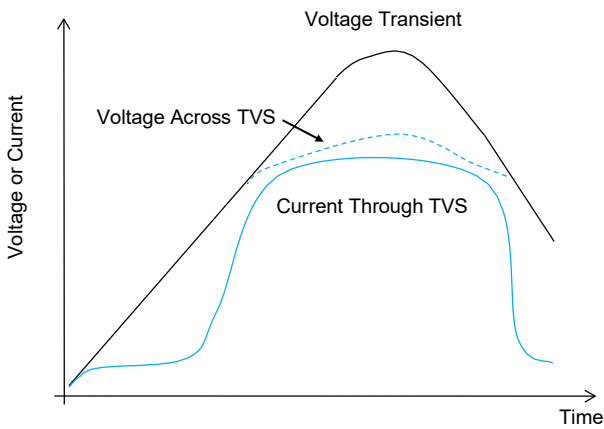

FIGURE 1 TVS Transients Clamping Waveform

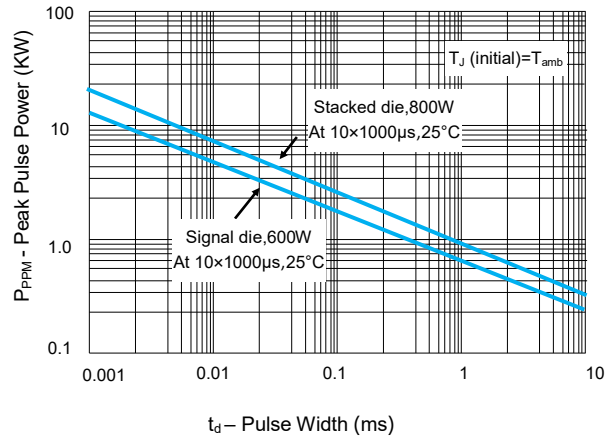

FIGURE 2 Peak Pulse Power Rating Curve

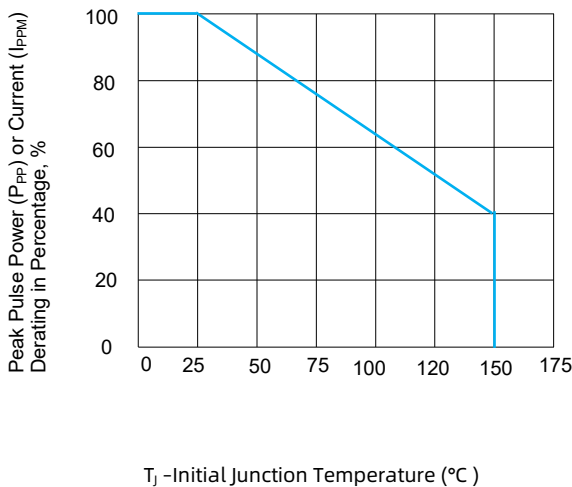

FIGURE 3 Peak Pulse Power Derating Curve

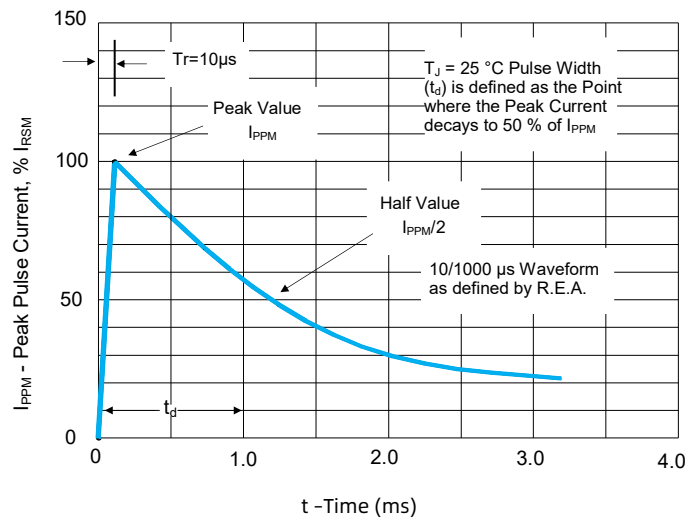

FIGURE 4 Pulse Waveform

TVS Diodes

Transient Voltage Suppression Diodes

SMAJ Series

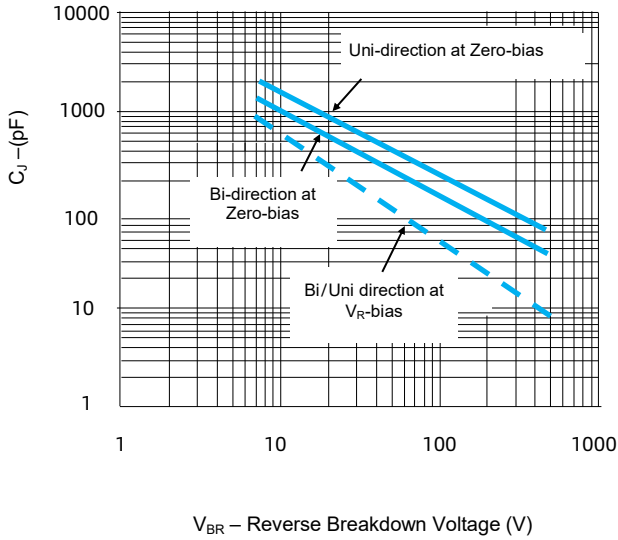

FIGURE 5 Typical Junction Capacitance

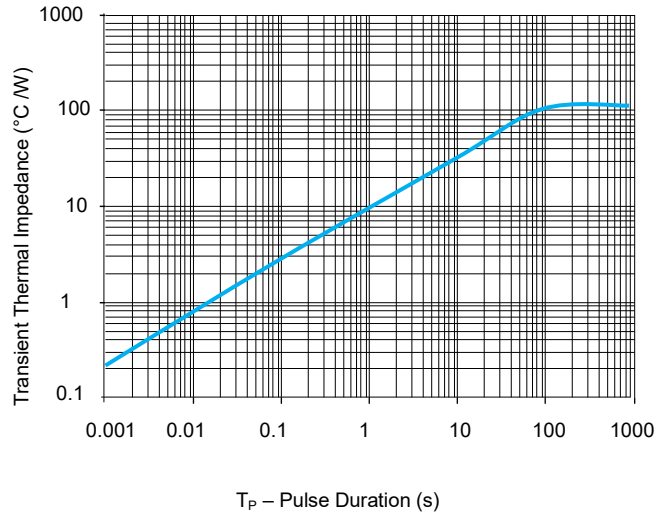

FIGURE 6 Typical Transient Thermal Impedance

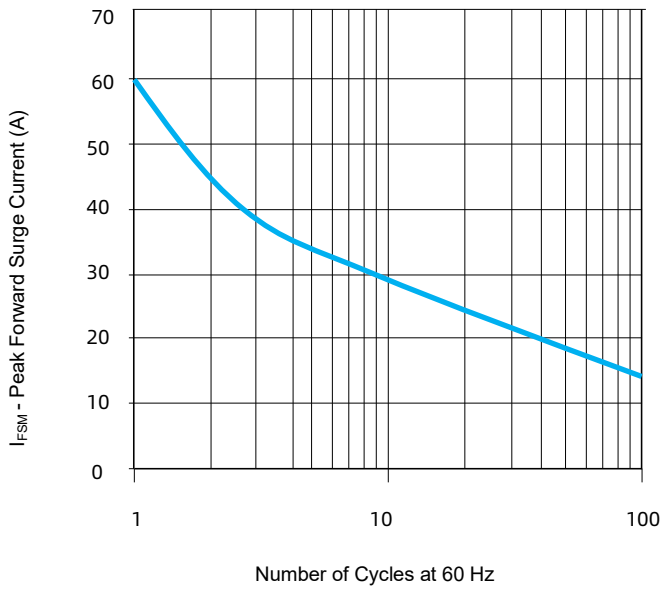

FIGURE 7 Maximum Non-Repetitive Forward Surge Current Uni-Directional only

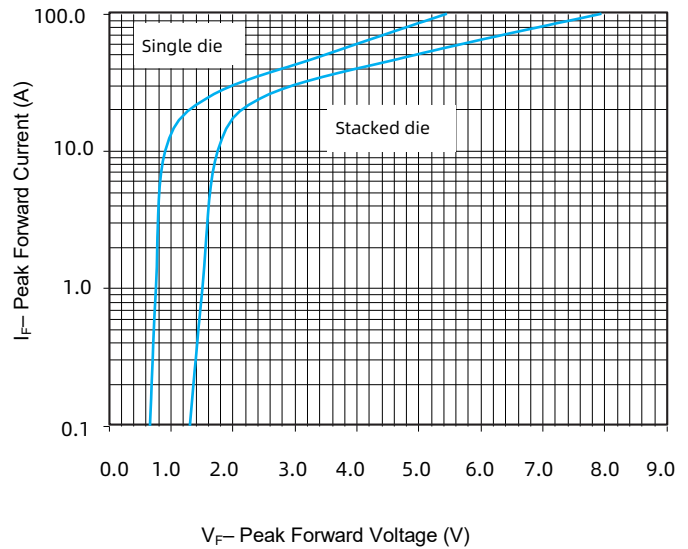

FIGURE 8 Peak Forward Drop vs Peak Forward Current (Typical Values)

Environmental Specifications

High Temp. Storage	JESD22-A103
HTRB	JESD22-A108
Temperature Cycling	JESD22-A104
MSL	JESDEC-J-STD-020, Level 1
H3TRB	JESD22-A101
RSH	JESD22-A111

Physical Specifications

Weight	0.002ounce,0.061grams
Case	JESD22DO214AC. Molded plastic body over glass passivated junction
Polarity	Color band denotes positive end (cathode) except Bidirectional
Terminal	Matte Tin-plated leads, Solderability per JESD22-B102

Soldering Parameters

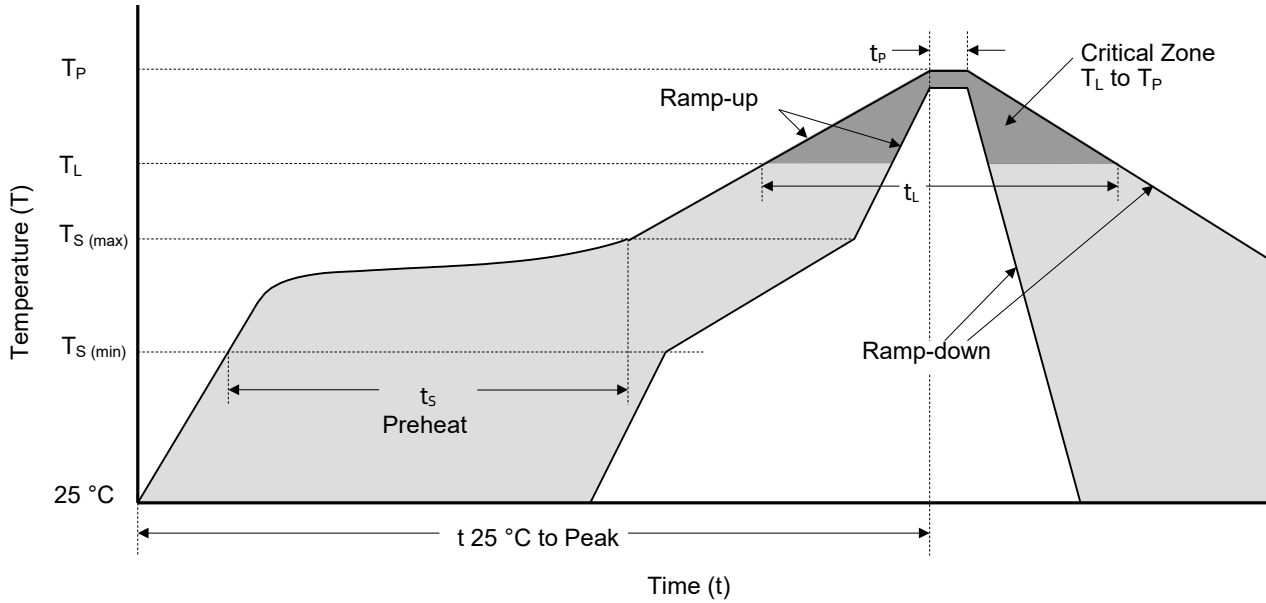

Reflowing Condition

Reflow Soldering Parameters		Lead-Free Assembly
Pre-heat	Temperature Min ($T_{S(min)}$)	150 °C
	Temperature Max ($T_{S(max)}$)	200 °C
	Time (min to max) (t_s)	60 ~ 120 seconds
Average Ramp Up Rate (Liquidus Temp (T_L) to Peak)		3 °C / second max.
$T_{S(max)}$ to T_L Ramp-up Rate		3 °C / second max.
Reflow	Temperature (T_L) (Liquidus)	217 °C
	Time (min to max) (t_L)	60 ~ 150 seconds
Peak Temperature (T_P)		260 ^{+0/-5} °C
Time of within 5 °C of Actual Peak Temperature (t_p)		20 ~ 40 seconds
Ramp-down Rate		6 °C / second max.
Time from 25 °C to Peak Temperature		8 Minutes max.
Do Not Exceed		260 °C

TVS Diodes

Transient Voltage Suppression Diodes

SMAJ Series

Packaging Information

Tape	Symbol	Dimension (mm)
	W	12.00 ± 0.30 / -0.10
	P ₀	4.00 ± 0.10
	P ₁	8.00 ± 0.10
	P ₂	2.00 ± 0.05
	D ₀	1.55 ± 0.05
	D ₁	1.55 ± 0.05
	E	1.75 ± 0.10
	F	5.50 ± 0.05
	A ₀	2.79 ± 0.10
	B ₀	5.33 ± 0.10
	K ₀	2.36 ± 0.10
	T	0.30 ± 0.05

Reel Size	13" Reel	
	A	330 mm
	C	13.2 mm
	W ₁	12.5 mm

Part Number	Package	QTY (Reel)	Packaging Option	Packaging Specification
SMAJxxx	DO-214AC	5000 PCS	Tape & Reel – 12 mm tape/13" reel	EIA STD RS-481



ATTENTION

Usage

1. TVS must be operated in the specified ambient temp.
2. Do not clean the TVS with strong polar solvent such as ketone, esters, benzene and halogenated hydrocarbon, to avoid damaging the encapsulating layer.
3. Please do not apply severe vibration, shock or pressure to TVS, to avoid element cracking.

Replacement

1. If TVS is visually damaged, please replace it.
2. TVS is a non-repairable product. For safety sake, please use equivalent TVS for replacement.

Storage

1. Storage Temp. Range: (-55 to 150) °C.
2. Do not store the TVS at the high temp., high humidity or corrosive gas environment, to avoid influencing the solder-ability of the lead wires. The product shall be used up within 1 year after receiving the goods.

Environmental Conditions

1. TVS should not be exposed to the open air, nor direct sunshine.
2. TVS should avoid rain, water vapor or other condition of high temp. and high humidity.
3. TVS should avoid sand dust, salt mist, or other harmful gases.

Max. Typical Capacitance of TVS

The typical capacitance of TVS is listed in the specifications. Designers may refer to it when designing TVS in High frequency circuit.

Installation Mechanical Stress

1. Do not knock TVS when installing, to avoid mechanical damage.
2. Please do not apply severe vibration, shock or pressure to TVS, to avoid surface resin or element cracking.