

TPR

Thermally Protected Resistor (Active Protection)

TPRD Series



Dimensions (mm)

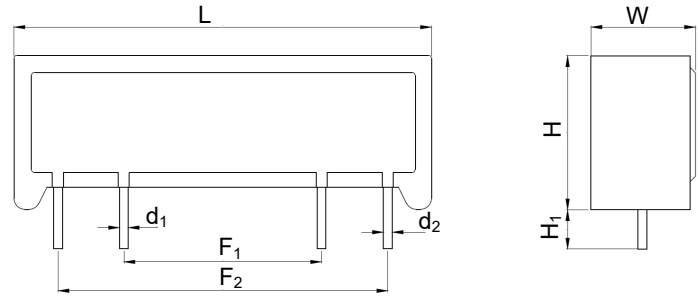

L	W	H	H ₁	F ₁ ^a
38 ± 1	9 ± 1	14 ± 1	3.5 ± 0.8	18.0 ± 1.0
F ₂ ^a	d ₁	d ₂	-	-
30.4 ± 1.0	Φ0.54 ± 0.05	Φ0.75 ± 0.05	-	-

^a: The forming modes and length of length of lead wires can be customized.

Description

Thermally Protected Resistor (TPR) is an active protection integrated component, where Alloy Thermal-Link (ATCO) and resistor are in parallel encapsulated in a ceramic case with silicone cement.

Features

- Over Temp. Protection
- Over Current Protection
- Inrush Current Protection
- Active Protection
- RoHS Compliant

Applications

- Industrial Equipment

Structure Diagrams

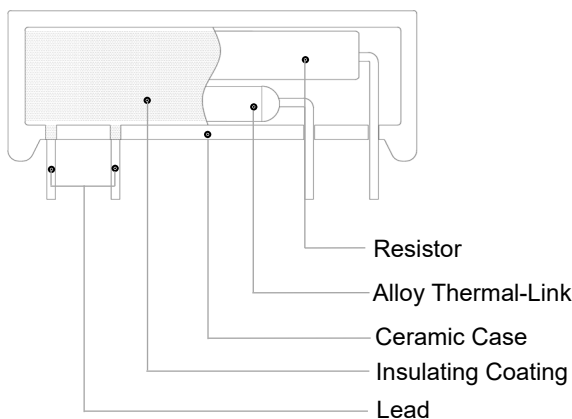

Agency Approvals

Agency	Standards	No.
	UL1412	Pending
	SJ 2865	Pending

Part Numbering System

TPR D - 4R7 J 26 F B H - 001

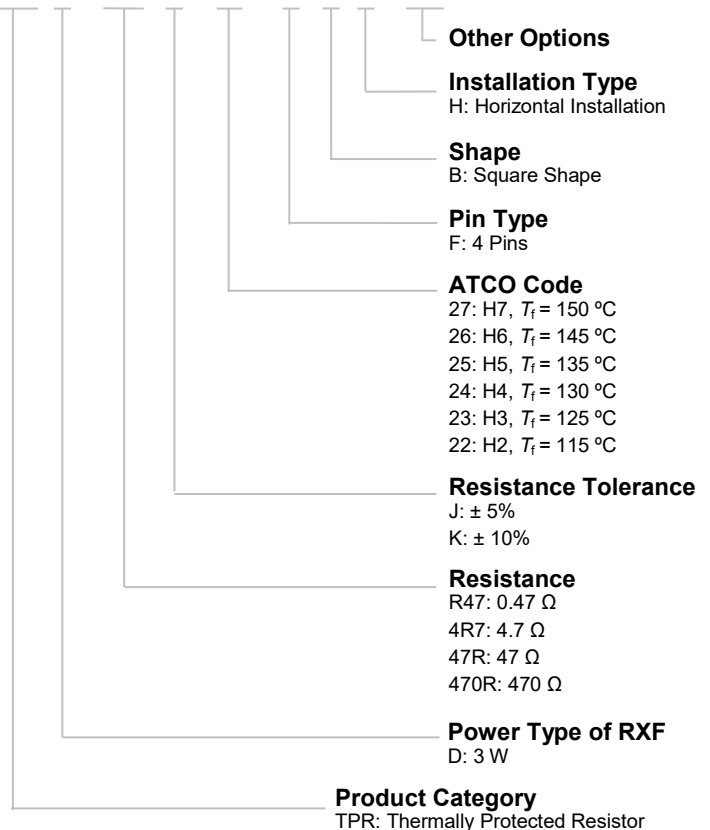

Other Options

Installation Type

H: Horizontal Installation

Shape

B: Square Shape

Pin Type

F: 4 Pins

ATCO Code

- 27: H7, $T_t = 150\text{ °C}$
- 26: H6, $T_t = 145\text{ °C}$
- 25: H5, $T_t = 135\text{ °C}$
- 24: H4, $T_t = 130\text{ °C}$
- 23: H3, $T_t = 125\text{ °C}$
- 22: H2, $T_t = 115\text{ °C}$

Resistance Tolerance

- J: ± 5%
- K: ± 10%

Resistance

- R47: 0.47 Ω
- 4R7: 4.7 Ω
- 47R: 47 Ω
- 470R: 470 Ω

Power Type of RXF

D: 3 W

Product Category

TPR: Thermally Protected Resistor

TPR

TPR

Technical Parameter

Item	Parameter
Power Type of Resistor (<i>P</i>)	3 W
Rated Resistance of Resistor (<i>R</i>)	0.27 Ω ~ 1,000 Ω
Resistance Tolerance of Resistor	5% (E24) , 10% (E12)
Rated Current of Resistor (<i>I_N</i>)	$I_N = \sqrt{P / R}$
Rated Voltage of Resistor (<i>U_N</i>)	$U_N = \sqrt{P \times R}$
Rated Current of ATCO	2 A
Rated Voltage of ATCO	125 VAC, 250 VAC
Fusing Time (less than 60 seconds)	35 W (115 °C ≤ <i>T_f</i> ≤ 135 °C) 40 W (145 °C ≤ <i>T_f</i> ≤ 150 °C)
Maximum Fusing Current	Current That Correspond to 160 W
Fusing Temp.	See Specifications
Surge of Resistance	2.0 kV (<i>R</i> > 10 Ω) 1.0 kV (<i>R</i> ≤ 10 Ω)

Remark:

- 1.TPR fusing current of product is the current pass through resistor cause the opening of ATCO.
2. If the fault current pass through resistor exceeds the Maximum Fusing Current, ATCO would not open.

Fusing Time Current (For Reference Only)

TPR can open effectively at lower power multiples to protect the circuit timely (ambient temp. 25 °C ± 2°C).

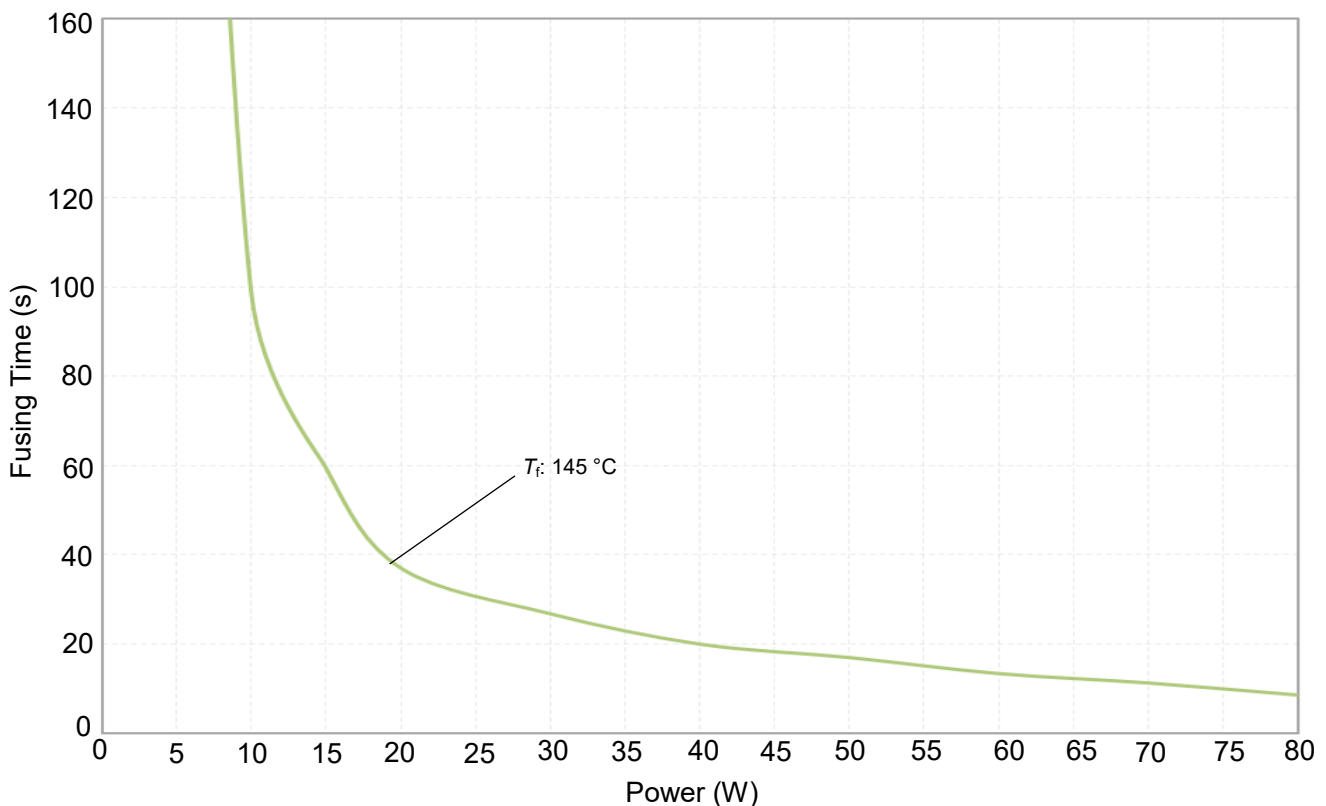



TPR

TPR

Specifications

Blue Font Is SETsafe | SETfuse Common Specifications

Model	Power Type	Rated Functioning Temp. (T _r)	Fuse Temp.	Resistance Range	Resistance Tolerance	Agency Approvals		Environmental Status
								RoHS
	(W)	(°C)	(°C)	(Ω)	(%)	cURus	CQC	RoHS
TPRD-xxxx27FB	3	150	143 ~ 150	0.27 ~ 1000	± 5, ±10	Pending	Pending	●
TPRD-xxxx26FB	3	145	138 ~ 145	0.27 ~ 1000	± 5, ±10	Pending	Pending	●
TPRD-xxxx25LB	3	135	128 ~ 135	0.27 ~ 1000	± 5, ±10	Pending	Pending	●
TPRD-xxxx24LB	3	130	123 ~ 130	0.27 ~ 1000	± 5, ±10	Pending	Pending	●
TPRD-xxxx23LB	3	125	119 ~ 125	0.27 ~ 1000	± 5, ±10	Pending	Pending	●
TPRD-xxxx22FB	3	115	109 ~ 115	0.27 ~ 1000	± 5, ±10	Pending	Pending	●

Resistance Selection Table (According to IEC60063-2015 E24)

Rated Resistance	Code	Rated Resistance	Code	Rated Resistance	Code	Rated Resistance	Code
(Ω)		(Ω)		(Ω)		(Ω)	
0.10	R10	1.0	1R0	10	10R	100	100R
0.11	R11	1.1	1R1	11	11R	110	110R
0.12	R12	1.2	1R2	12	12R	120	120R
0.13	R13	1.3	1R3	13	13R	130	130R
0.15	R15	1.5	1R5	15	15R	150	150R
0.16	R16	1.6	1R6	16	16R	160	160R
0.18	R18	1.8	1R8	18	18R	180	180R
0.20	R20	2.0	2R0	20	20R	200	200R
0.22	R22	2.2	2R2	22	22R	220	220R
0.24	R24	2.4	2R4	24	24R	240	240R
0.27	R27	2.7	2R7	27	27R	270	270R
0.30	R30	3.0	3R0	30	30R	300	300R
0.33	R33	3.3	3R3	33	33R	330	330R
0.36	R36	3.6	3R6	36	36R	360	360R
0.39	R39	3.9	3R9	39	39R	390	390R
0.43	R43	4.3	4R3	43	43R	430	430R
0.47	R47	4.7	4R7	47	47R	470	470R
0.51	R51	5.1	5R1	51	51R	510	510R
0.56	R56	5.6	5R6	56	56R	560	560R
0.62	R62	6.2	6R2	62	62R	620	620R
0.68	R68	6.8	6R8	68	68R	680	680R
0.75	R75	7.5	7R5	75	75R	750	750R
0.82	R82	8.2	8R2	82	82R	820	820R
0.91	R91	9.1	9R1	91	91R	910	910R





TPR

TPR

Glossary

Item	Description
RXF	Fusible Wirewound Resistor A power resistor which is made by winding a resistive element on a ceramic core, and the core is coated by insulation coating. It intends to interrupt a current flow at a predetermined time when the current exceeds the predetermined value, It is non-resettable.
ATCO	Alloy Thermal-Link Alloy Type Thermal-Link, alloy is the thermal element. Thermal-Link is A non-resettable device incorporating a THERMAL ELEMENT which will open a circuit once only when exposed for a sufficient length of time to a temp. in excess of that for which it has been designed.
R	Rated Resistance Resistance value for which the resistor has been designed, and which is generally used for denomination of the resistor.
I_N	Rated Current Current calculated from the square root of the quotient of rated dissipation divided by rated resistance.
U_N	Rated Voltage The d.c. or a.c. r.m.s. voltage calculated from the square root of the product of the rated resistance and the rated dissipation.
T_f	Rated Functioning Temp. The temp. of the Thermal-Link which causes it to change its state of conductivity with a detection current up to 10 mA as the only load.
Fusing Temp.	Fusing Temp. The temp. of the TPR which causes it to change its state of conductivity is measured with silicone oil bath in which the temp. is increased at the rate of 0.3 °C to 0.5 °C / min, with a detection current up to 10 mA as the only load.

Agency Approvals of ATCO

Code	Model	Rated Functioning Temp. (°C)	Agency Approvals				
			 cURus	 TUV	 PSE	 CCC	 KC
27	H7	150	●	●	●	●	●
26	H6	145	●	●	●	●	●
25	H5	135	●	●	●	●	●
24	H4	130	●	●	●	●	●
23	H3	125	●	●	●	●	●
22	H2	115	●	●	●	●	●

TPR

Thermally Protected Resistor (Active Protection)

TPRD Series

Marking

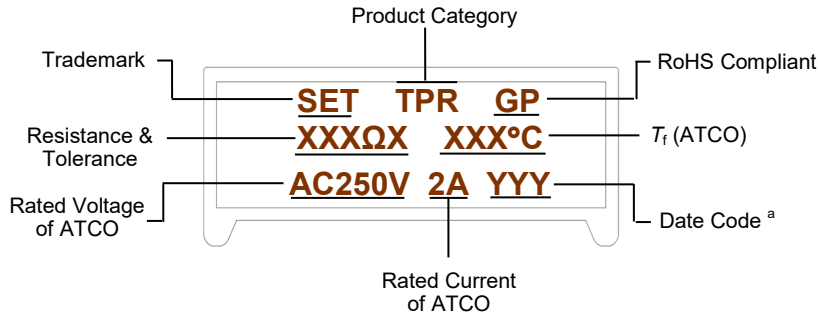

Note:

a: The first YY means production year code,

The last Y means production quarter code.

eg: "221" means that the production time is the first quarter of Y2022.

Note: The color of schematic diagram is for reference only

Operating Principle

Instruction:

$$R_R \geq 100R_{ATCO}$$

- R_R : The Resistance Value of Resistor
- R_{ATCO} : The Resistance Value of ATCO

$$T_{RXF} \geq 5T_{ATCO}$$

- The Fusing Temp. of ATCO (T_{ATCO}): 102 °C ~ 150 °C

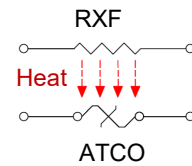
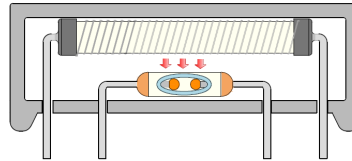

Soldering Parameters

Recommended Hand-Soldering Parameters

Max. Allowable Soldering Time (s)			Soldering Temp. (°C)	Legend
Length of Lead Wire (L_0)				
3.5 mm	4.5 mm	5.5 mm		
3	4	6	400	

Remark: Auxiliary heat sink fixture is required to avoid Thermal-Link cutting off unexpectedly.

Performance Test

Mechanical Performance Test

Item	Test Condition	Criterion
Tensile Test	A pin withstand 10 N × 60 seconds	No Visible Damage, $\Delta R \leq \pm (1\%R + 0.05 \Omega)$
Twist Test	A pin 2 mm away from body, bent 90°, twist 180° × 2 times	No Visible Damage, $\Delta R \leq \pm (1\%R + 0.05 \Omega)$

Environmental Test

Item	Test Condition	Criterion
Temp. Cycle	1. - 55 °C × 30 minutes 2. Room Temp. × (10 to 15) minutes 3. 85 °C × 30 minutes 4. Room Temp. × (10 to 15) minutes 5. 5 Cycles from Step 1 to Step 4	$\Delta R \leq \pm (2\%R + 0.05 \Omega)$

Electrical Performance Test

Item	Test Condition	Criterion
Short-Time Overload	$2.5U_N \times 5$ seconds	Legible Marking, No Visible Damage $\Delta R \leq \pm (2\%R + 0.05 \Omega)$
Insulation Resistance	Foil Method: Apply 500 VDC between lead wire and the metal foil.	Insulation Resistance $\geq 1,000 M\Omega$
Voltage Proof	Foil Method: Apply 900 VAC × 1 minute between pin and the metal foil.	No Breakdown or Flashover
Surge Test	Combination Wave Generator (1.2/50 μ s, 8/20 μ s, 2 Ω), 10 Times, 1 minute Interval.	Resistor shall not open after the test
Fusing Test	Apply test current to the resistor (constant current source).	Fusing Time ≤ 60 seconds
Solderability	Solder Bath (non-activated flux), Soldering Powder: 25% Rosin Alcohol, Depth of Immersion (From the seating plane or component body): (1.5 to 2.0) mm, Time of Immersion: (2.5 \pm 0.5) seconds.	Soldering Area $\geq 95\%$
Fusing Temp.	Silicone oil bath: temp. rise rate is 0.3 °C/min to 0.5 °C/min, detection current ≤ 10 mA.	143 °C ~ 150 °C ($T_f = 150$ °C) 138 °C ~ 145 °C ($T_f = 145$ °C) 128 °C ~ 135 °C ($T_f = 135$ °C) 123 °C ~ 130 °C ($T_f = 130$ °C) 119 °C ~ 125 °C ($T_f = 125$ °C) 109 °C ~ 115 °C ($T_f = 115$ °C)

Packaging Information (For Reference Only)

Item	Tray	Carton
Quantity (PCS)	280 PCS	1,120 PCS
Gross Weight (kg)		12 ± 10%

Unit: mm

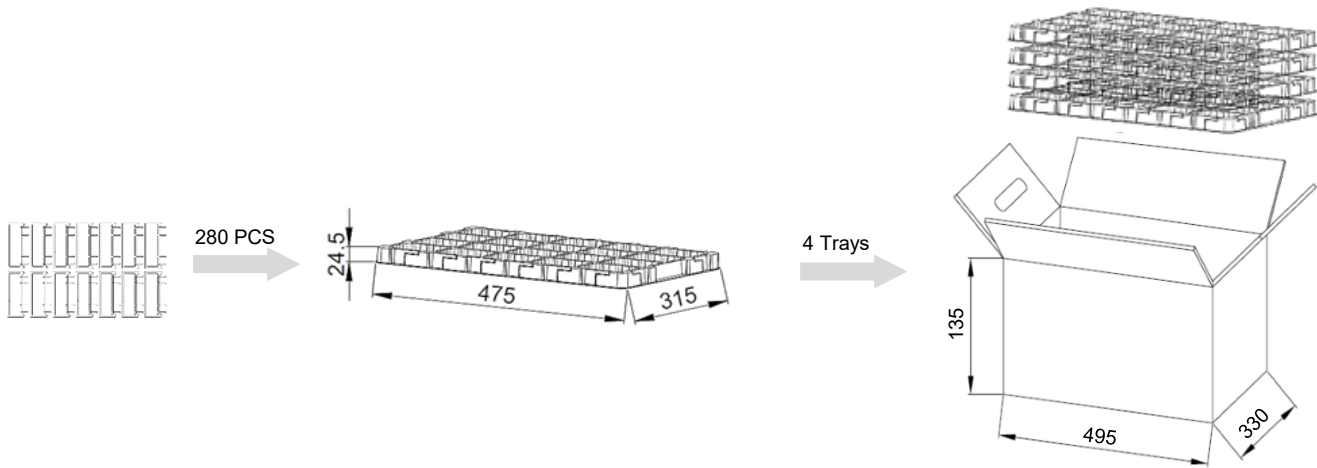



ATTENTION

Cold Resistance Test

1. If product TCR is not less than 350 ($10^{-6}/^{\circ}\text{C}$), the measured resistance value shall be corrected as the relative resistance value under 25 °C according to TCR formula.
2. Resistance Measurement (4-terminal test).

Replacement

As TPR is a non-resettable product, for safety sake, please use the same type of TPR for replacement.

Usage

1. Do not touch the resistor body or pins directly when power is on, to avoid burn or electric shock.
2. When air pressure is from 80 kPa to 106 kPa, the relative altitude shall be +2000 m to - 500 m.

Storage

1. Please store TPR with ambient temp. 10 °C ~ 30 °C and relative humidity 30% ~ 75%.
2. Do not store the TPR at the high temp., high humidity or corrosive gas environment, avoid influencing the solderability of the pins, please use them up within 1 year after receiving the goods.