



Description

The Gas Discharge Tube (GDT) is a protective device which is filled with certain proportion of noble gas, or mixed gas or other discharge media in the space between metal electrodes and metalized ceramics, and then sealed at high temperature to form a single-gap or multi-gap switch type protective device. When the protected circuit or equipment suffers to surge, GDT will change from high impedance state to low impedance state and release the surge energy to reduce the residual voltage of the circuit, and then protect the equipment or humanbody from the hazard of transient overvoltage.

Agency Approvals

Agency	Standards	File No.
	UL497B	E513446
	TUV	On-going

Features

- Fast Response
- Stable Performance Over Surface Life
- High Current Rating
- Low Capacitance
- High Insulation Resistance
- RoHS & REACH Compliant

Applications

- WLAN XDSL
- CATV
- MDF
- Ethernet
- BTS (Base Station)
- Power Supply
- Antenna and RF
- Consumer Electronics
- N-PE Protection in AC Power

Dimensions (mm)

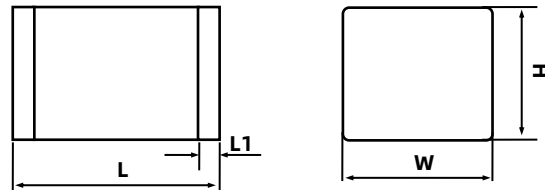

L	W	H	L1
3.2 ± 0.3	2.5 ± 0.2	2.5 ± 0.2	0.4

Part Number System

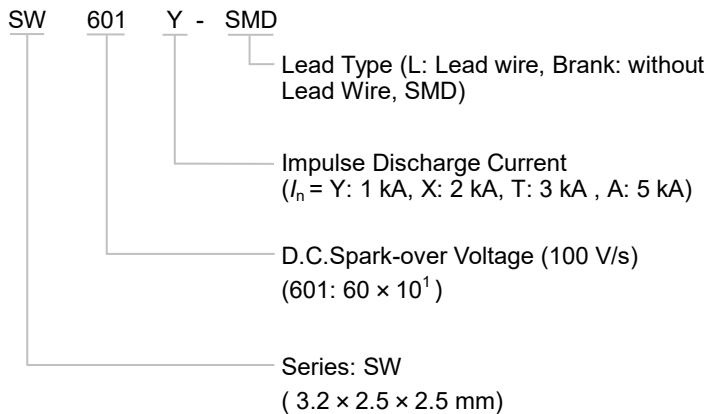

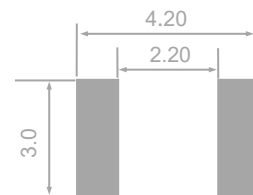

Recommendation Pad Size (mm)



Glossary

Item	Description
V_s	<p>D.C. Spark-over Voltage The voltage at which the GDT sparks over with slowly increasing d.c. voltage.</p> <p>— (IEC 61643-311)</p>
V	<p>Impulse Spark-over Voltage The highest Voltage which appears across the terminals of a GDT in the period between the application of an impulse of given wave-shape and the time when current begins to flow.</p> <p>— (ITU-T K.12)</p>
V_a	<p>Arc Voltage Voltage drop across the GDT during arc current flow.</p> <p>— (IEC 61643-311)</p>
V_{gl}	<p>Glow Voltage The peak value of the voltage drop across the GDT when a glow-current is flowing, It is sometimes called the glow mode voltage.</p> <p>— (ITU-T K.12)</p>
$8/20 \mu s$	<p>8/20 Current Impulse Current impulse with a nominal virtual front time of 8 μs and a nominal time to half-value of 20 μs.</p> <p>— (IEC 61643-11)</p>
$1.2/50 \mu s$	<p>1.2/50 Voltage Impulse Voltage impulse with a nominal virtual front time of 1.2 μs and a nominal time to half-value of 50 μs.</p> <p>— (IEC 61643-11)</p>
I	<p>Alternating Discharge Current The r.m.s. value of an approximately sinusoidal alternating current passing through the GDT.</p> <p>— (ITU-T K.12)</p>
I_n	<p>Nominal Discharge Current Crest value of the current through the GDT having a current waveshape of 8/20 μs.</p> <p>— (IEC 61643-11)</p>
I_{max}	<p>Maximum Discharge Current Crest value of a current through the GDT having an 8/20 μs waveshape and magnitude according to the manufacturers specification. I_{max} is equal to or greater than I_n.</p> <p>— (IEC 61643-11)</p>

Specifications

Model	D.C. Spark-over Voltage @100 V/s	Tolerance of V_s	Impulse Spark-over Voltage @1 kV/ μ s	Arc Voltage @1 A	Impulse Discharge Current @8/20 μ s	Alternating Discharge Current @50Hz 1 s	Insulation Resistance		Capacitance 0.5 VDC @ 1MHz	Agency Approvals	
	V_s	V_s	V	V_a	I_n	I	V_{DC}	IR	C		
	V	V	V	V	kA	A (r.m.s.)	V	G Ω	(pF)	UL497B	TUV
SW075Y - SMD	75	57 ~ 93	≤ 650	≈ 8	1	1	50	≥ 1	≤ 0.6	●	○
SW091Y - SMD	90	72 ~ 108	≤ 600	≈ 8	1	1	50	≥ 1	≤ 0.6	●	○
SW151Y - SMD	150	120 ~ 180	≤ 600	≈ 8	1	1	50	≥ 1	≤ 0.6	●	○
SW201Y - SMD	200	160 ~ 240	≤ 700	≈ 10	1	1	100	≥ 1	≤ 0.6	●	○
SW231Y - SMD	230	184 ~ 280	≤ 700	≈ 10	1	1	100	≥ 1	≤ 0.6	●	○
SW301Y - SMD	300	240 ~ 360	≤ 800	≈ 10	1	1	100	≥ 1	≤ 0.6	●	○
SW351Y - SMD	350	280 ~ 420	≤ 1000	≈ 10	1	1	100	≥ 1	≤ 0.6	●	○
SW401Y - SMD	400	320 ~ 480	≤ 1000	≈ 10	1	1	100	≥ 1	≤ 0.6	●	○
SW421Y - SMD	420	336 ~ 504	≤ 1000	≈ 12	1	1	100	≥ 1	≤ 0.6	●	○
SW471Y - SMD	470	376 ~ 564	≤ 1200	≈ 12	1	1	100	≥ 1	≤ 0.6	●	○
SW601Y - SMD	600	480 ~ 720	≤ 1400	≈ 15	1	1	100	≥ 1	≤ 0.6	●	○

Note:

1. The above parameters based on ITU - T K12 & IEC61643.311 standards.
2. "●" means GDT has gained the certification.
"○" means GDT is planned to apply for certification.

GDT

GDT

Reference Curve for Spark-over Voltage (Refer to 230 VDC)

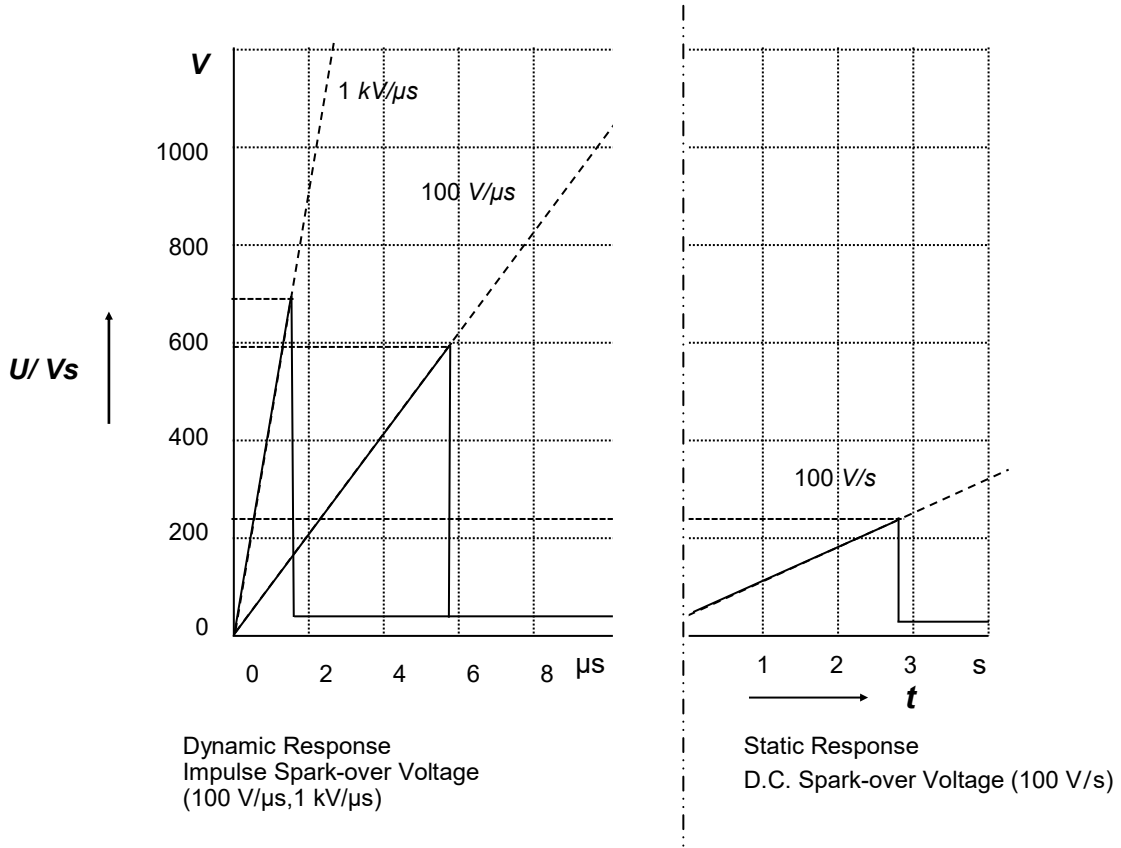

Reference Curve for Impulse Discharge Current

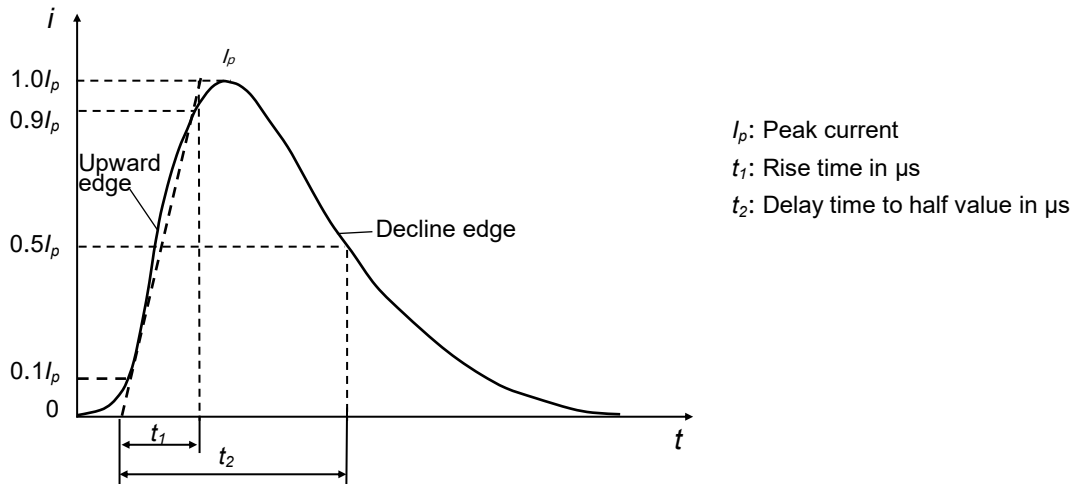

Electrical Characteristics

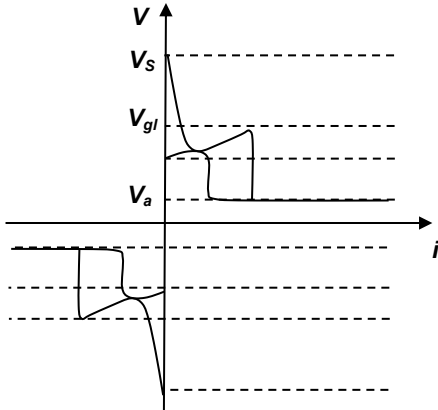

Relationship between Current and Voltage

- V_s : Spark-over Voltage
- V_{gl} : Glow Voltage
- V_a : Arc Voltage
- G : Glow Mode
- A : Arc Mode

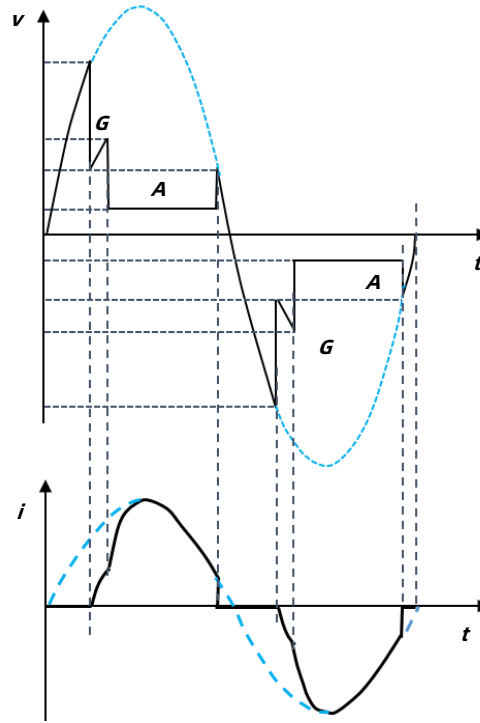

Time Variation Patterns of Voltage and Current

Application Example

AC Power Protection

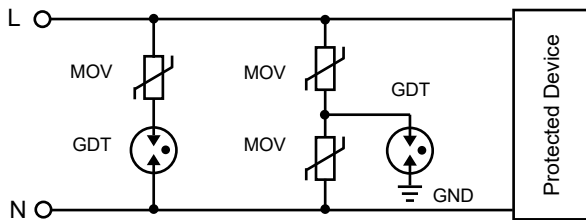

2-Electrod GDT Signal Circuit Protection

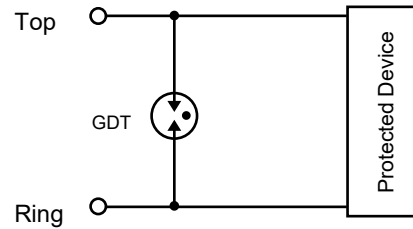

DC Power Protection

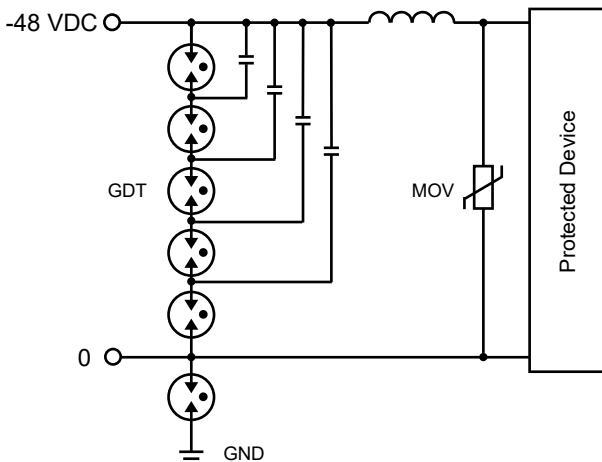

3-Electrod GDT Signal Circuit Protection

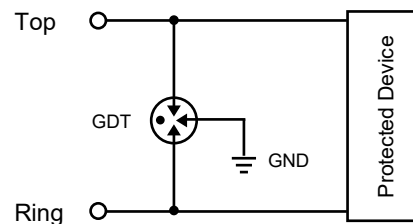

Reflow Soldering Parameters (For Reference Only)

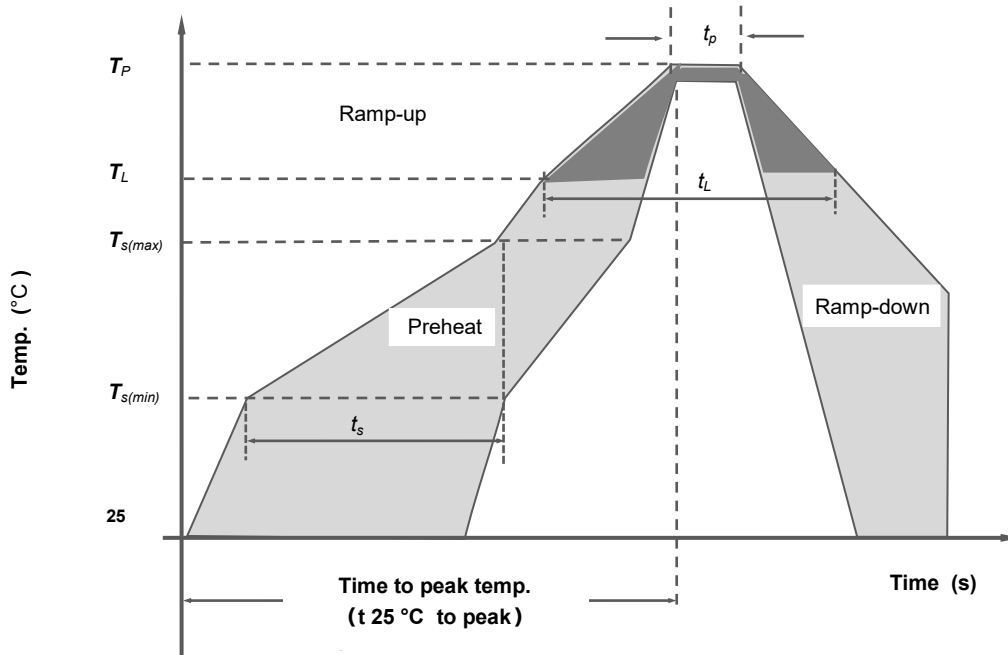

Reflow Condition		Pb-Free Assembly
Preheat	Temp. Min $T_{s(min)}$	150 °C
	Temp. Max $T_{s(max)}$	200 °C
	Time (Min to Max) t_s	(60 to 180) s
Average ramp up rate (Liquidus Temp. (T_L) to peak)		3 °C / second max
$T_{s(max)}$ to T_L Ramp-up Rate		5 °C / second max
Reflow	Temp. (T_L) (Liquidus)	217 °C
	Temp. (t_L)	(60 to 150) s
Peak Temp. (T_P)		(255 to 260) °C
Time within 5 °C of actual peak Temp. (t_p)		(10 to 30) s
Ramp-down Rate		6 °C / second max
Time 25 °C to peak Temp. (T_P)		8 minutes max
Do not exceed		260 °C

GDT

GDT

Packaging Information

Item	Reel	Inner Box	Carton
Dimensions (mm)	Φ330 × 12.8	340 × 340 × 40	360 × 360 × 360
Quantity (PCS)	2500	5000	40000

Notes: Packaging dimensions and quantity are for reference only.

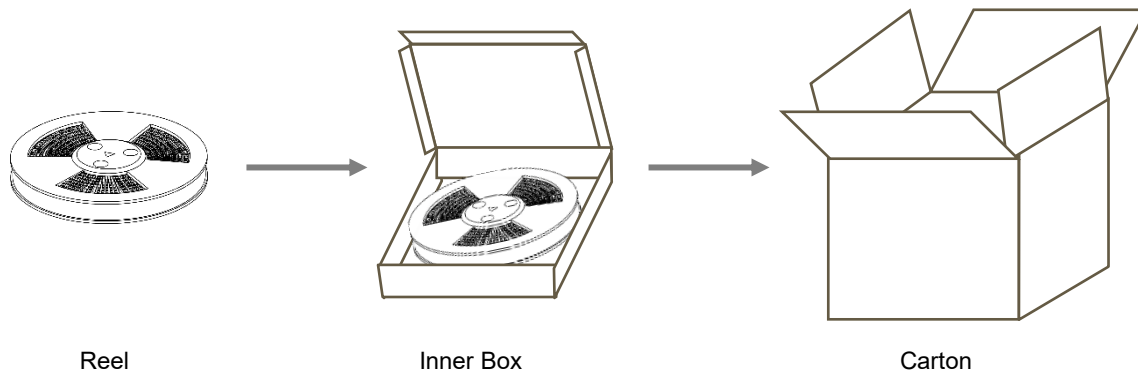

Please refer to the specifications for the packaging details.



ATTENTION

Usage

1. Do not operate GDT in power supply networks, whose maximum operation voltage exceeds the minimum spark-overvoltage of the GDT.
2. The GDT may become hot in the event of longer periods of current stress (burn risk). In the event of overload the connectors may fail or the component may be destroyed.
3. If the contacts of GDT are defective, current load can cause sparks and loud noises.
4. When air pressure is from 55 kPa to 106 kPa. The relative altitude shall be +5000 m to -500 m.

Replacement

The GDT is a non-repairable product. For safety sake, please use equivalent GDT for replacement.

Storage

The packaged GDT should be placed in a dry, ventilation and non-corrosive environment.

Installation Position

Do not install the GDT in a touchable position.

Mechanical Stress

Do not take violent action such as knocking when assembling, to avoid product failure.